

AGENDA
DD 56 LANDOWNER MEETING
Wednesday, March 31, 2021 10:30 AM
Hardin County Emergency Operations Center (EOC)
1031 Edgington, Ave., Eldora, IA

This meeting will be open to the public for in-person attendance at the EOC building, attendance is also available electronically either by conference call or online.

To access the meeting call: 1-(312)-626-6799, when prompted enter meeting ID code: 820 7567 2007

You can also access the meeting online at:
<https://us02web.zoom.us/j/82075672007>

1. Open Meeting
2. Approve Agenda
3. Introductions/Attendance
4. DD 56 - Discuss Upper Main Tile Diversion Bids
This Landowner Meeting is to discuss bids received on the DD 56 Upper Main Tile Diversion Project. The Trustees have not yet awarded the bid and would like to encourage all landowners to attend and provide input about which options landowners would like to consider.

Documents:

[DD 56 6830.4 BID TAB- UPPER MAIN TILE DIVERSION.PDF](#)
[DD 56 - 1. 6830.4- PROJECT SPECIFICATIONS BOOK 1 OF 2.PDF](#)
[DD 56 - 2. 6830.4 GENERAL SPECIFICATIONS BOOK 2 OF 2.PDF](#)
[DD 56 - 4. 6830.4 PLAN SET.PDF](#)

5. Comments/Discussion
6. Possible Action On Bids
7. Other Business
8. Adjourn Meeting



Project: Upper Main Tile Diversion DD 56
Date: March 10, 2021
Engineer: Lee Gallentine

Gehrke Inc.
1405 21st Ave.
Eldora, IA 50627

Brian Nettleton Excavating Inc.
269 370th Street
Joice, IA 50446

Holland Contracting Corp.
1400 South 4th Street
Forest City, IA 50436

Weidemann Inc.
105 South Tracy
Dows, IA 50071

Engineers Est. \$700,000

Item No.	Description	Estimated Quantity	Unit	Unit Price	Bid Price	Unit Price	Bid Price	Unit Price	Bid Price	Unit Price	Bid Price
DD 56 BASE BID											
1	48" Ø RCP Tile	4,634	LF	\$ 175.00	\$ 810,950.00	\$ 190.00	\$ 880,460.00	\$ 209.00	\$ 968,506.00	\$ 250.00	\$ 1,158,500.00
2	48" Ø CMP Tile Outlet	40	LF	\$ 154.00	\$ 6,160.00	\$ 162.00	\$ 6,480.00	\$ 220.00	\$ 8,800.00	\$ 273.35	\$ 10,934.00
3	72" Junction Structure	2	EA	\$ 7,150.00	\$ 14,300.00	\$ 5,900.00	\$ 11,800.00	\$ 8,000.00	\$ 16,000.00	\$ 10,000.00	\$ 20,000.00
4	Concrete Collar	3	EA	\$ 330.00	\$ 990.00	\$ 1,000.00	\$ 3,000.00	\$ 900.00	\$ 2,700.00	\$ 1,400.00	\$ 4,200.00
5	Private Tile Connection	10	EA	\$ 500.00	\$ 5,000.00	\$ 1,100.00	\$ 11,000.00	\$ 600.00	\$ 6,000.00	\$ 2,280.00	\$ 22,800.00
6	12" Ø Hickenbottom Intake	1	EA	\$ 1,300.00	\$ 1,300.00	\$ 1,640.00	\$ 1,640.00	\$ 1,900.00	\$ 1,900.00	\$ 2,100.00	\$ 2,100.00
7	Rip-Rap	50	TN	\$ 39.50	\$ 1,975.00	\$ 64.00	\$ 3,200.00	\$ 65.00	\$ 3,250.00	\$ 52.95	\$ 2,647.50
8	Tile Removal	30	LF	\$ 10.00	\$ 300.00	\$ 20.00	\$ 600.00	\$ 12.00	\$ 360.00	\$ 20.00	\$ 600.00
9	Fences	1	LS	\$ 1,200.00	\$ 1,200.00	\$ 1,500.00	\$ 1,500.00	\$ 8,500.00	\$ 8,500.00	\$ 5,000.00	\$ 5,000.00
10	Road Ditch Grading	2	STA	\$ 650.00	\$ 1,300.00	\$ 500.00	\$ 1,000.00	\$ 350.00	\$ 700.00	\$ 1,000.00	\$ 2,000.00
11	Outlet Shaping	1	LS	\$ 650.00	\$ 650.00	\$ 1,000.00	\$ 1,000.00	\$ 1,000.00	\$ 1,000.00	\$ 1,000.00	\$ 1,000.00
12	Dewatering	1	LS	\$ 20,000.00	\$ 20,000.00	\$ 15,000.00	\$ 15,000.00	\$ 20,000.00	\$ 20,000.00	\$ 25,000.00	\$ 25,000.00
13	Exploratory Excavation	2	HR	\$ 525.00	\$ 1,050.00	\$ 300.00	\$ 600.00	\$ 450.00	\$ 900.00	\$ 500.00	\$ 1,000.00
14	Bonding	1	LS	\$ 8,000.00	\$ 8,000.00	\$ 15,000.00	\$ 15,000.00	\$ 38,000.00	\$ 38,000.00	\$ 18,000.00	\$ 18,000.00
15	Seeding	1	LS	\$ 7,000.00	\$ 7,000.00	\$ 7,000.00	\$ 7,000.00	\$ 27,000.00	\$ 27,000.00	\$ 8,000.00	\$ 8,000.00
16	Seeding Warranty	1	LS	\$ 1,000.00	\$ 1,000.00	\$ 100.00	\$ 100.00	\$ 13,500.00	\$ 13,500.00	\$ 200.00	\$ 200.00
DD 56 BASE BID TOTAL (BID ITEMS 1-16)				\$ 881,175.00	\$ 959,380.00	\$ 1,117,116.00	\$ 1,281,981.50				

Item No.	Description	Estimated Quantity	Unit	Unit Price	Bid Price	Unit Price	Bid Price	Unit Price	Bid Price	Unit Price	Bid Price
DD 56 ALTERNATE BID											
1ALT	48" Ø Polypropylene Tile	4,634	LF	\$ 180.00	\$ 834,120.00		\$ -		\$ -		\$ -
2ALT	48" Ø CMP Tile Outlet	40	LF	\$ 154.00	\$ 6,160.00		\$ -		\$ -		\$ -
3ALT	72" Junction Structure	2	EA	\$ 7,150.00	\$ 14,300.00		\$ -		\$ -		\$ -
4ALT	Concrete Collar	3	EA	\$ 330.00	\$ 990.00		\$ -		\$ -		\$ -
5ALT	Private Tile Connection	10	EA	\$ 500.00	\$ 5,000.00		\$ -		\$ -		\$ -
6ALT	12" Ø Hickenbottom Intake	1	EA	\$ 1,300.00	\$ 1,300.00		\$ -		\$ -		\$ -
7ALT	Rip-Rap	50	TN	\$ 39.50	\$ 1,975.00		\$ -		\$ -		\$ -
8ALT	Tile Removal	30	LF	\$ 10.00	\$ 300.00		\$ -		\$ -		\$ -
9ALT	Fences	1	LS	\$ 1,200.00	\$ 1,200.00		\$ -		\$ -		\$ -
10ALT	Road Ditch Grading	2	STA	\$ 650.00	\$ 1,300.00		\$ -		\$ -		\$ -
11ALT	Outlet Shaping	1	LS	\$ 650.00	\$ 650.00		\$ -		\$ -		\$ -
12ALT	Dewatering	1	LS	\$ 35,000.00	\$ 35,000.00		\$ -		\$ -		\$ -
13ALT	Exploratory Excavation	2	HR	\$ 525.00	\$ 1,050.00		\$ -		\$ -		\$ -
14ALT	Bonding	1	LS	\$ 8,000.00	\$ 8,000.00		\$ -		\$ -		\$ -
15ALT	Seeding	1	LS	\$ 7,000.00	\$ 7,000.00		\$ -		\$ -		\$ -
16ALT	Seeding Warranty	1	LS	\$ 1,000.00	\$ 1,000.00		\$ -		\$ -		\$ -
DD 56 BASE BID TOTAL (BID ITEMS 1ALT-16ALT)				\$ 919,345.00	\$ -	\$ -	\$ -				

Item No.	Description	Estimated Quantity	Unit	Unit Price	Bid Price	Unit Price	Bid Price	Unit Price	Bid Price	Unit Price	Bid Price
DD 56 ADD ALTERNATES BID											
1ADD	Mandrel Testing of Tile	4,674	LF	\$ 5.00	\$ 23,370.00	\$ 1.00	\$ 4,674.00	\$ 2.00	\$ 9,348.00	\$ 1.00	\$ 4,674.00
2ADD	CCTV Inspection of Tile	4,674	LF	\$ 5.00	\$ 23,370.00	\$ 3.00	\$ 14,022.00	\$ 4.00	\$ 18,696.00	\$ 3.00	\$ 14,022.00
3ADD	Trench Compaction	46.74	STA	\$ 500.00	\$ 23,370.00	\$ 460.00	\$ 21,500.40	\$ 180.00	\$ 8,413.20	\$ 4,000.00	\$ 186,960.00
4ADD	Mandrel and CCTV Access Point	4	EA	\$ 6,000.00	\$ 24,000.00	\$ 3,750.00	\$ 15,000.00	\$ 12,000.00	\$ 48,000.00	\$ 5,650.00	\$ 22,600.00
5ADD	Additional 2' of Installation Depth	4,674	LF	\$ 1.00	\$ 4,674.00	\$ 15.00	\$ 70,110.00	\$ 35.00	\$ 163,590.00	\$ 15.00	\$ 70,110.00
BID ADD ALTERNATE #1 TOTAL (BID ITEMS 1ADD-5ADD)				\$ 98,784.00	\$ 125,306.40	\$ 248,047.20	\$ 298,366.00				

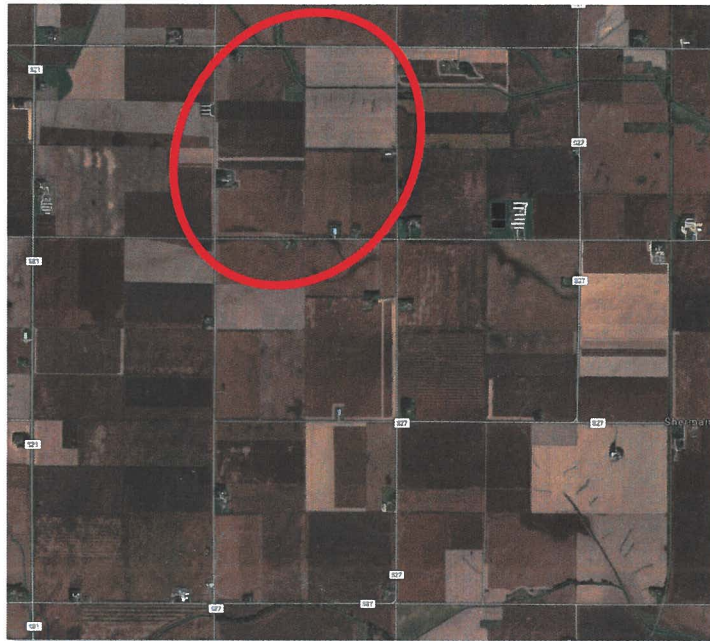

**SPECIFICATIONS
FOR
UPPER MAIN TILE
DIVERSION
DRAINAGE DISTRICT 56,
HARDIN COUNTY
(PROJECT NO. 6830.4)**

	<p>I HEREBY CERTIFY THAT THIS ENGINEERING DOCUMENT WAS PREPARED BY ME OR UNDER MY DIRECT PERSONAL SUPERVISION AND THAT I AM A DULY LICENSED PROFESSIONAL ENGINEER UNDER THE LAWS OF THE STATE OF IOWA</p> <p><i>Lee O. Gallentine</i> LEE O. GALLENTINE, P.E. DATE <u>Feb 17, 2021</u></p> <p>LICENSE NUMBER: 15745 MY LICENSE RENEWAL DATE IS DECEMBER 31, 2022 PAGES OR SHEETS COVERED BY THIS SEAL: SHOWN ON TABLE OF CONTENTS</p>
---	--

(BOOK 1 OF 2)

	<p><u>CLAPSADDLE-GARBER ASSOCIATES OFFICE LOCATIONS</u></p> <p>16 East Main Street, PO Box 754 Marshalltown, IA 50158 1523 S. Bell Avenue, Suite 101 Ames, IA 50010 5106 Nordic Drive Cedar Falls, IA 50613 739 Park Avenue Ackley, IA 50601 511 Bank Street Webster City, IA 50595</p>	<p><u>Project Office</u> 739 Park Avenue Ackley, IA. 50601 Phone: 641-847-3273 Fax: 641-847-2303</p>
---	--	---

SPECIFICATIONS
FOR UPPER MAIN TILE DIVERSION
DRAINAGE DISTRICT 56, HARDIN COUNTY
(PROJECT NO. 6830.4)

2021

(BOOK 1 OF 2)

	<u>PAGES</u>
TITLE SHEET	
TABLE OF CONTENTS	
BIDDING INFORMATION AND CONTRACT FORMS	
Notice to Bidders	N-1 thru N-2
Description & Summary of Project	1 Page
Instructions to Bidders	1 thru 11
Bid Form	1 thru 7
Agreement Between Owner and Contractor	1 thru 7
(This Agreement Supersedes Sample Agreement in Book 2)	
DETAILED SPECIFICATIONS	
Detailed Specifications	1 thru 6

THIS PAGE LEFT BLANK INTENTIONALLY

NOTICE TO BIDDERS
FOR UPPER MAIN TILE DIVERSION
DRAINAGE DISTRICT 56, HARDIN COUNTY
(PROJECT NO. 6830.4)

Notice is hereby given that sealed bids will be received by the **County Auditor of Hardin County, Iowa, at their office in the Hardin County Courthouse, 1215 Edgington Avenue, Suite 1, Eldora, Iowa 50627, until 10:00 a.m. on March 10, 2021** for Main tile diversion of Drainage District 56, Hardin County, Iowa. Plans, specifications and form of contract are on file at the office of the County Auditor and describe the work involved and the conditions under which it is to be performed. Bids will be opened by the Engineer and the Board of Supervisors of Hardin County (acting District Trustees) at a meeting to be held in the Courthouse of Hardin County at 10:00 a.m. on March 10, 2021. Said bids will be acted on at a time and date to be determined at said bid opening. Plans and specifications governing the construction of the proposed improvements have been prepared by CGA, 739 Park Avenue, Ackley Iowa; phone 641-847-3273. Copies of the plans and specifications for this project can be downloaded at no charge from www.cgaplanroom.com or a printed copy can be obtained by contacting Beeline + Blue at 2507 Ingersoll Ave., Des Moines, IA 50312 or by phone at 515-244-1611. A \$50 refundable deposit is required for all printed plan sets and specifications. The fee is REFUNDABLE, provided the following conditions are met: 1) The plans and specifications are returned to CGA complete and in good usable condition and 2) they are returned to the above address within fourteen (14) calendar days after the award of the project.

The proposed work is located in Section 4, Township 87 North, Range 22 West in Hardin County, Iowa and consists of the furnishing of all materials, labor, and equipment to complete the approximate quantities of work, all as described in the plans and specifications and as listed as below. One contract will be awarded for all divisions of this project.

The proposed work consists of 4,674 feet of 48” tile; private tile connections; concrete collars; 72” junction structure; intakes; seeding; dewatering; mobilization; and other associated work.

All bids must be filed with the County Auditor on or before the time herein stated. All bids shall be made on forms furnished by the Owner’s Engineer and contained in the specifications and must be enclosed in a separate sealed envelope and plainly identified. Each proposal shall be accompanied by deposit of cash, bid bond, cashier’s or certified check, or a credit union certified share draft, in a separate sealed envelope in an amount equal to five percent (5%) of the total amount of the bid. The certified or cashier’s check, if used, shall be drawn on a bank in Iowa or a bank chartered under the laws of the United States or said certified share draft should be drawn on a credit union in Iowa or chartered under the laws of the United States; and such check or share draft shall be made payable to the Hardin County Auditor as security that if awarded a contract by resolution of said Supervisors, the Bidder will enter into a contract at the prices bid and furnish the required performance and payment bond and certificate of insurance. The deposit of cash shall be retained, certified or cashier’s check or certified share draft may be cashed, or the bid bond redeemed, if the Contractor fails to enter into a contract, or fails to provide a certificate of insurance within ten (10) days after the acceptance of his proposal by resolution of the County Supervisors. No bidder may withdraw a bid within sixty (60) days after the date set for opening bids. If awarded, one (1) contract will be awarded to the lowest, responsive bidder for base bid or one of the alternate bids.

The successful bidder shall be required to execute a performance and payment bond, with sureties approved by the County Auditor in favor of the Drainage Districts for the use and benefit of the Drainage Districts and to all persons entitled to liens for labor or material, in an amount not less than one hundred percent (100%) of the contract price of the work to be done, conditioned for the timely, efficient, and complete

performance of his contracts, and the payment, as they become due, of all just claims for labor performed and material used in carrying out the contract. When the contract is executed and the performance bond approved, the certified check, share draft, cash deposited, or bid bond provided with the bid shall be returned to the bidder. The performance bond shall be provided at the time the contract for work is signed.

Payment to the Contractor will be made in monthly estimates of ninety percent (90%) of the work completed during the period as provided in Section 468.100, Code of Iowa. Pursuant to Sections 468.101 through 468.103, the balance will be paid not less than 30 days after acceptance of the work by the County Supervisors acting as Trustees of the Drainage District. **All payments to the Contractor shall be made by the County Treasurer by check. No payments shall be made by drainage warrants.**

The work under the proposed contract shall begin within 15 days of the Notice to Proceed. All work is to be completed by December 31, 2021 including seeding and finishing work. The Contractor shall pay the said District Five Hundred (\$500.00) per day as liquidated damages for each calendar day the work remains uncompleted after the completion date stated above.

Published upon the order of the Board of Supervisors of Hardin County (acting as District Trustees), who also reserve the right to reject any or all proposals and to waive informalities and technicalities.

BY: Hardin County Auditor

DESCRIPTION AND SUMMARY OF PROJECT

This project is for Main tile diversion for Drainage District 56 in Hardin County. The proposed work is located in Section 4, Township 87 North, Range 22 West in Hardin County, Iowa and is shown more particularly on the project plans.

This project involves severing the upper portion of the existing Main tile from the lower portion north of 230th Street in Section 4. Then installing new Diversion Main tile north and east through Section 4 to a new outlet on the Main open ditch of Drainage District 26.

THIS PAGE LEFT BLANK INTENTIONALLY

ARTICLE 1 – DEFINED TERMS

- 1.01 Terms used in these Instructions to Bidders have the meanings indicated in the General Conditions and Supplementary Conditions. Additional terms used in these Instructions to Bidders have the meanings indicated below:
- A. *Issuing Office* – The office from which the Bidding Documents are to be issued and where the bidding procedures are to be administered.
 - B. *Bidder* – One who submits a Bid directly to the Owner as a distinct from a sub-bidder, who submits a bid to a Bidder.
 - C. *Successful Bidder* – Lowest, responsible and responsive Bidder to whom the Owner (on the basis of Owner’s evaluation as hereinafter provided) makes an award if the Owner chooses to move forward with the Project.

ARTICLE 2 – COPIES OF BIDDING DOCUMENTS

- 2.01 Complete sets of the Bidding Documents in the number and for the deposit sum, if any, stated in the advertisement or invitation to bid may be obtained from the Issuing Office. All of the deposit will be refunded to each document holder of record who returns a complete set of Bidding Documents in undamaged and reusable condition within 14 days after award of the project.
- 2.02 Complete sets of Bidding Documents shall be used in preparing Bids; neither Owner nor Engineer assumes any responsibility for errors or misinterpretations resulting from the use of incomplete sets of Bidding Documents.
- 2.03 Owner and Engineer, in making copies of Bidding Documents available on the above terms, do so only for the purpose of obtaining Bids for the Work and do not authorize or confer a license for any other use.

ARTICLE 3 – QUALIFICATIONS OF BIDDERS

- 3.01 To demonstrate Bidder’s qualifications to perform the Work, within 48 hours of Owner’s request, Bidder shall submit written evidence such as financial data, previous experience, present commitments, and such other data as may be called for below.
- 3.02 Evidence of Bidder’s authority to do business in the state of Iowa where the Project is located or covenant to obtain such qualifications prior to award of Contract
- 3.03 Bidder is advised to carefully review those portions of the Bid Form requiring Bidder’s representations and certifications.

ARTICLE 4 – EXAMINATION OF BIDDING DOCUMENTS, OTHER RELATED DATA, AND SITE

- 4.01 *Subsurface and Physical Conditions (Not Used)*
- 4.02 *Underground Facilities*

- A. Information and data shown or indicated in the Bidding Documents with respect to existing Underground Facilities at or contiguous to the Site is based upon best available information and data furnished to Owner and Engineer by owners of such Underground Facilities, including Owner, or others.
- 4.03 *Hazardous Environmental Condition*
- A. The Supplementary Conditions identify any reports and drawings known to Owner relating to a Hazardous Environmental Condition identified at the Site.
 - B. Copies of reports and drawings, if any, referenced in Paragraph 4.03.A will be made available by Owner to any Bidder on request. Those reports and drawings are not part of the Contract Documents, but the “technical data” contained therein upon which Bidder is entitled to rely as provided in Paragraph 4.06 of the General Conditions has been identified and established in Paragraph 4.06 of the Supplementary Conditions. Bidder is responsible for any interpretation or conclusion Bidder draws from any “technical data” or any other data, interpretations, opinions, or information contained in such reports or shown or indicated in such drawings.
- 4.04 Provisions concerning responsibilities for the adequacy of data furnished to prospective Bidders with respect to subsurface conditions, other physical conditions, and Underground Facilities, and possible changes in the Bidding Documents due to differing or unanticipated subsurface or physical conditions appear in Paragraphs 4.02, 4.03, and 4.04 of the General Conditions. Provisions concerning responsibilities for the adequacy of data furnished to prospective Bidders with respect to a Hazardous Environmental Condition at the Site, if any, and possible changes in the Contract Documents due to any Hazardous Environmental Condition uncovered or revealed at the Site which was not shown or indicated in the Drawings or Specifications or identified in the Contract Documents to be within the scope of the Work, appear in Paragraph 4.06 of the General Conditions.
- 4.05 On request, Owner will provide Bidder access to the Site to conduct such examinations, investigations, explorations, tests, and studies as Bidder deems necessary for submission of a Bid. Bidder shall fill all holes and clean up and restore the Site to its former condition upon completion of such explorations, investigations, tests, and studies. Bidder shall comply with all applicable Laws and Regulations relative to excavation and utility locates. All restorations shall be completed prior to bid opening.
- 4.06 A. Reference is made to Article 7 of the Supplementary Conditions for the identification of the general nature of other work that is to be performed at the Site by Owner or others (such as utilities and other prime contractors) that relates to the Work contemplated by these Bidding Documents. On request, Owner will provide to each Bidder for examination access to or copies of contract documents (other than portions thereof related to price) for such other work.
- B. Paragraph 6.13.C of the General Conditions indicates that if an Owner safety program exists, it will be noted in the Supplementary Conditions.
- 4.07 It is the responsibility of each Bidder before submitting a Bid to:
- A. examine and carefully study the Bidding Documents, and the other related data identified in the Bidding Documents; (including any “Technical Data” referred below)

- B. visit the Site and become familiar with and satisfy Bidder as to the general, local, and Site conditions that may affect cost, progress, and performance of the Work;
 - C. become familiar with and satisfy Bidder as to all federal, state, and local Laws and Regulations that may affect cost, progress, and performance of the Work;
 - D. carefully study all: drawings of physical conditions relating to existing surface or subsurface structures at the Site (except Underground Facilities) that have been identified in Paragraph 4.02 of the Supplementary Conditions as containing reliable "technical data."
 - E. consider the information known to Bidder; information commonly known to contractors doing business in the locality of the Site; information and observations obtained from visits to the Site; the Bidding Documents; and the Site-related reports and drawings identified in the Bidding Documents, with respect to the effect of such information, observations, and documents on (1) the cost, progress, and performance of the Work; (2) the means, methods, techniques, sequences, and procedures of construction to be employed by Bidder, including applying any specific means, methods, techniques, sequences, and procedures of construction expressly required by the Bidding Documents; and (3) Bidder's safety precautions and programs;
 - F. agree at the time of submitting its Bid that no further examinations, investigations, explorations, tests, studies, or data are necessary for the determination of its Bid for performance of the Work at the price(s) bid and within the times required, and in accordance with the other terms and conditions of the Bidding Documents;
 - G. become aware of the general nature of the work to be performed by Owner and others at the Site that relates to the Work as indicated in the Bidding Documents;
 - H. promptly give Engineer written notice of all conflicts, errors, ambiguities, or discrepancies that Bidder discovers in the Bidding Documents and confirm that the written resolution thereof by Engineer is acceptable to Bidder; and
 - I. determine that the Bidding Documents are generally sufficient to indicate and convey understanding of all terms and conditions for the performance of the Work.
- 4.08 The submission of a Bid will constitute an incontrovertible representation by Bidder that Bidder has complied with every requirement of this Article 4, that without exception the Bid is premised upon performing and furnishing the Work required by the Bidding Documents and applying any specific means, methods, techniques, sequences, and procedures of construction that may be shown or indicated or expressly required by the Bidding Documents, that Bidder has given Engineer written notice of all conflicts, errors, ambiguities, and discrepancies that Bidder has discovered in the Bidding Documents and the written resolutions thereof by Engineer are acceptable to Bidder, and that the Bidding Documents are generally sufficient to indicate and convey understanding of all terms and conditions for performing and furnishing the Work.
- 4.09 The submission of a Bid will constitute an incontrovertible representation by Bidder that Bidder has complied with every requirement of this Article 4, that without exception the Bid is premised upon performing and furnishing the Work required by the Bidding Documents and applying any specific means, methods, techniques, sequences, and procedures of construction that may be shown or indicated or expressly required by the Bidding Documents, that Bidder

has given Engineer written notice of all conflicts, errors, ambiguities, and discrepancies that Bidder has discovered in the Bidding Documents and the written resolutions thereof by Engineer are acceptable to Bidder, and that the Bidding Documents are generally sufficient to indicate and convey understanding of all terms and conditions for performing and furnishing the Work.

ARTICLE 5 – PRE-BID CONFERENCE

5.01 *(Not Required)*

ARTICLE 6 – SITE AND OTHER AREAS

6.01 The Site is identified in the Bidding Documents. Easements for permanent structures or permanent changes in existing facilities are to be obtained and paid for by Owner unless otherwise provided in the Bidding Documents. All additional lands and access thereto required for temporary construction facilities, construction equipment, or storage of materials and equipment to be incorporated in the Work are to be obtained and paid for by Contractor.

ARTICLE 7 – INTERPRETATIONS AND ADDENDA

7.01 All questions about the meaning or intent of the Bidding Documents are to be submitted to Engineer in writing.

Mr. Lee O. Gallentine, P.E.
Clapsaddle-Garber Associates, Inc.
739 Park Avenue
Ackley, Iowa 50601
Phone: 641-847-3273 Fax: 641-847-2303

Interpretations or clarifications considered necessary by Engineer in response to such questions will be issued by Addenda mailed or delivered to all parties recorded by Engineer as having received the Bidding Documents. Questions received less than five days prior to the date for opening of Bids may not be answered. Only questions answered by Addenda will be binding. Oral and other interpretations or clarifications will be without legal effect.

7.02 Addenda may be issued to clarify, correct, or change the Bidding Documents as deemed advisable by Owner or Engineer.

ARTICLE 8 – BID SECURITY

8.01 A Bid must be accompanied by Bid security made payable to Owner in an amount as set out in the Notice Of Hearing and Letting or Bid Bond Form and in the form of a cashier's or certified check, bank money order, or a bid bond issued by a surety meeting the requirements of Paragraphs 5.01 and 5.02 of the General Conditions.

8.02 The Bid security of the Successful Bidder will be retained until such Bidder has executed the Contract Documents, furnished the required contract security and met the other conditions of the Notice of Award, whereupon the Bid security will be returned. If the Successful Bidder fails to execute and deliver the Contract Documents and furnish the required contract security within 10 days after the Notice of Award, Owner may consider Bidder to be in default, annul

the Notice of Award, and the Bid security of that Bidder will be forfeited. Such forfeiture shall be Owner's exclusive remedy if Bidder defaults. The Bid security of other Bidders whom Owner believes to have a reasonable chance of receiving the award may be retained by Owner until the earlier of seven days after the Effective Date of the Agreement or 61 days after the Bid opening, whereupon Bid security furnished by such Bidders will be returned.

8.03 Bid security of other Bidders whom Owner believes do not have a reasonable chance of receiving the award will be returned within seven days after the Bid opening.

8.04 Make Bid Security Payable as stated in the Notice.

ARTICLE 9 – CONTRACT TIMES

9.01 The number of days within which, or the dates by which, the Work is to be substantially completed and ready for final payment are set forth in the Agreement.

ARTICLE 10 – LIQUIDATED DAMAGES

10.01 Provisions for liquidated damages, if any, are set forth in the Agreement. Time is of the essence for this project. If the Contractor fails to substantially complete the work covered by this project by the specified completion date, or by the extended completion date as authorized in writing by the Owner, it is acknowledged and agreed that the Owner will suffer loss and damages. In the event of a failure to timely complete the project, such loss or damages shall be paid for as liquidated damages. The Owner and Contractor agree that as liquidated damages for the delay (but not as a penalty), the Contractor shall pay to the Owner the sum of \$500.00 for each day that expires after the completion date, until the work is substantially completed. All field work shall be completed on or before the dates stated in the Notice. No time extensions shall be granted due to weather, construction delays, suppliers, subcontractors, or unexpected complications with the project. The Owner and Contractor agree that these sums are a reasonable and fair estimation of additional damages to be sustained by the Owner arising from the Contractor's failure to timely complete the project, given the nature and size of the project.

ARTICLE 11 – SUBSTITUTE AND “OR-EQUAL” ITEMS

11.01 The Contract, if awarded, will be on the basis of materials and equipment specified or described in the Bidding Documents without consideration of possible substitute or “or-equal” items. Whenever it is specified or described in the Bidding Documents that a substitute or “or-equal” item of material or equipment may be furnished or used by Contractor if acceptable to Engineer, application for such acceptance will not be considered by Engineer until after the Effective Date of the Agreement.

11.02 The procedure for submitting “or-equal” item applications by the Contractor to the Engineer for consideration is set forth in the General Conditions and may be supplemented in the General Requirements.

ARTICLE 12 – SUBCONTRACTORS, SUPPLIERS AND OTHERS

12.01 If the Supplementary Conditions require the identity of certain Subcontractors, Suppliers, individuals, or entities to be submitted to Owner in advance of a specified date prior to the Effective Date of the Agreement, the apparent Successful Bidder, and any other Bidder so requested, shall within two days after Bid opening, submit to Owner a list of all such

Subcontractors, Suppliers, individuals, or entities proposed for those portions of the Work for which such identification is required. Such list shall be accompanied by an experience statement with pertinent information regarding similar projects and other evidence of qualification for each such Subcontractor, Supplier, individual, or entity if requested by Owner. If Owner or Engineer, after due investigation, has reasonable objection to any proposed Subcontractor, Supplier, individual, or entity, Owner may, before the Notice of Award is given, request apparent Successful Bidder to submit a substitute, in which case apparent Successful Bidder shall submit an acceptable substitute, Bidder's Bid price will be increased (or decreased) by the difference in cost occasioned by such substitution, and Owner may consider such price adjustment in evaluating Bids and making the Contract award.

- 12.02 If apparent Successful Bidder declines to make any such substitution, Owner may award the Contract to the next lowest Bidder that proposes to use acceptable Subcontractors, Suppliers, individuals, or entities. Declining to make requested substitutions will not constitute grounds for forfeiture of the Bid security of any Bidder. Any Subcontractor, Supplier, individual, or entity so listed and against which Owner or Engineer makes no written objection prior to the giving of the Notice of Award will be deemed acceptable to Owner and Engineer subject to revocation of such acceptance after the Effective Date of the Agreement as provided in Paragraph 6.06 of the General Conditions.
- 12.03 Contractor shall not be required to employ any Subcontractor, Supplier, individual, or entity against whom Contractor has reasonable objection.
- 12.04 No Contractor shall be required to employ any subcontractor, supplier, other person or organization whom the contractor has reasonable objection when an alternate agreeable replacement can be found.

ARTICLE 13 – PREPARATION OF BID

- 13.01 The Bid Form is included with the Bidding Documents. Additional copies may be obtained from Engineer (or the issuing office).
- 13.02 All blanks on the Bid Form shall be completed in ink or typewriter and the Bid Form signed in ink. Erasures or alterations shall be initialed in ink by the person signing the Bid Form. A Bid price shall be indicated for each section, Bid item, alternative, adjustment unit price item, and unit price item listed therein. In the case of optional alternatives, the words "No Bid," "No Change," or "Not Applicable" may be entered.
- 13.03 A Bid by a corporation shall be executed in the corporate name by the president or a vice-president or other corporate officer accompanied by evidence of authority to sign. The corporate seal shall be affixed and attested by the secretary or an assistant secretary. The corporate address and state of incorporation shall be shown.
- 13.04 A Bid by a partnership shall be executed in the partnership name and signed by a partner (whose title must appear under the signature), accompanied by evidence of authority to sign. The official address of the partnership shall be shown.
- 13.05 A Bid by a limited liability company shall be executed in the name of the firm by a member and accompanied by evidence of authority to sign. The state of formation of the firm and the official address of the firm shall be shown.
- 13.06 A Bid by an individual shall show the Bidder's name and official address.

- 13.07 A Bid by a joint venture shall be executed by each joint venturer in the manner indicated on the Bid Form. The official address of the joint venture shall be shown.
- 13.08 All names shall be printed in ink below the signatures.
- 13.09 The Bid shall contain an acknowledgment of receipt of all Addenda, the numbers of which shall be filled in on the Bid Form.
- 13.10 Postal and e-mail addresses and telephone number for communications regarding the Bid shall be shown.
- 13.11 The Bid shall contain evidence of Bidder's authority and qualification to do business in the state where the Project is located, or Bidder shall covenant in writing to obtain such authority and qualification prior to award of the Contract and attach such covenant to the Bid. Bidder's state contractor license number, if any, shall also be shown on the Bid Form.

ARTICLE 14 – BASIS OF BID; COMPARISON OF BIDS

14.01 *Lump Sum (Not Required)*

14.02 *Unit Price*

- A. Bidders shall submit a Bid on a unit price basis for each item of Work listed in the Bid schedule.
- B. The total of all estimated prices will be the sum of the products of the estimated quantity of each item and the corresponding unit price. The final quantities and Contract Price will be determined in accordance with Paragraph 11.03 of the General Conditions.
- C. Discrepancies between the multiplication of units of Work and unit prices will be resolved in favor of the unit prices. Discrepancies between the indicated sum of any column of figures and the correct sum thereof will be resolved in favor of the correct sum.
- D. Each Bid shall cover complete work including costs incidental thereto. Bid shall include all costs of permits, fees, and similar expenses.

14.03 *Allowances*

- A. For cash allowances, the Bid price shall include such amounts as the Bidder deems proper for Contractor's overhead, costs, profit, and other expenses on account of cash allowances, if any, named in the Contract Documents, in accordance with Paragraph 11.02.B of the General Conditions.

14.04 *Completion Time Comparisons*

(Not Required)

ARTICLE 15 – SUBMITTAL OF BID

- 15.01 With each copy of the Bidding Documents, a Bidder is furnished one separate unbound copy of the Bid Form, and, if required, the Bid Bond Form. The unbound copy of the Bid Form is to be completed and submitted with the Bid security and the following documents:

J:\6830.4-DD\04-Design-Project Management\Bid Documents\Project-Specification (Working File)\4.Instruction to Bidders.docx

INSTRUCTION TO BIDDERS

PAGE 7

15.02 A Bid shall be submitted no later than the date and time prescribed and at the place indicated in the advertisement or invitation to bid and shall be enclosed in a plainly marked opaque package with the Project title (and, if applicable, the designated portion of the Project for which the Bid is submitted), the name and address of Bidder, and shall be accompanied by the Bid security and other required documents. If a Bid is sent by mail or other delivery system, the sealed envelope containing the Bid shall be enclosed in a separate package plainly marked on the outside with the notation "BID ENCLOSED." A mailed Bid shall be addressed to

TO: HARDIN COUNTY AUDITOR
C/O DRAINAGE CLERK
HARDIN COUNTY COURTHOUSE
1215 EDGINGTON AVENUE, SUITE 1
ELDORA, IOWA 50627

BID FOR: DRAINAGE DISTRICT 56

15.03 Contractor shall retain a copy of the Bid.

ARTICLE 16 – MODIFICATION AND WITHDRAWAL OF BID

16.01 A Bid may be modified or withdrawn by an appropriate document duly executed in the same manner that a Bid must be executed and delivered to the place where Bids are to be submitted prior to the date and time for the opening of Bids.

16.02 If within 24 hours after Bids are opened any Bidder files a duly signed written notice with Owner and promptly thereafter demonstrates to the reasonable satisfaction of Owner that there was a material and substantial mistake in the preparation of its Bid, that Bidder may withdraw its Bid, and the Bid security will be returned. Thereafter, if the Work is rebid, that Bidder will be disqualified from further bidding on the Work.

ARTICLE 17 – OPENING OF BIDS

17.01 Bids will be opened at the time and place indicated in the Advertisement or Invitation to Bid and, unless obviously non-responsive, read aloud publicly. An abstract of the amounts of the base Bids and major alternates, if any, will be made available to Bidders after the opening of Bids.

ARTICLE 18 - BIDS TO REMAIN SUBJECT TO ACCEPTANCE

18.01 All Bids will remain subject to acceptance for the period of time stated in the Bid Form, but Owner may, in its sole discretion, release any Bid and return the Bid security prior to the end of this period.

ARTICLE 19 – EVALUATION OF BIDS AND AWARD OF CONTRACT

19.01 Owner reserves the right to reject any or all Bids, including without limitation, nonconforming, nonresponsive, unbalanced, or conditional Bids. Owner further reserves the right to reject the

Bid of any Bidder whom it finds, after reasonable inquiry and evaluation, to not be responsible. Owner may also reject the Bid of any Bidder if Owner believes that it would not be in the best interest of the Project to make an award to that Bidder whether because the Bid is not responsive or the Bidder is unqualified or of doubtful financial ability, or unfavorable past experience working for the Owner, or fails to meet any other pertinent standard, or criteria established by the Owner. Owner also reserves the right to waive all informalities not involving price, time, or changes in the Work and to negotiate contract terms with the Successful Bidder.

- 19.02 More than one Bid for the same Work from an individual or entity under the same or different names will not be considered. Reasonable grounds for believing that any Bidder has an interest in more than one Bid for the Work may be cause for disqualification of that Bidder and the rejection of all Bids in which that Bidder has an interest.
- 19.03 In evaluating Bids, Owner will consider whether or not the Bids comply with the prescribed requirements, and such alternates, unit prices and other data, as may be requested in the Bid Form or prior to the Notice of Award.
- 19.04 In evaluating Bidders, Owner will consider the qualifications and experience of Bidders and may consider the qualifications and experience of Subcontractors, Suppliers, and other individuals or entities proposed for those portions of the Work for which the identity of Subcontractors, Suppliers, and other individuals or entities must be submitted as provided in the Supplementary Conditions.
- 19.05 Owner may conduct such investigations as Owner deems necessary to establish the responsibility, qualifications, and financial ability of Bidders, proposed Subcontractors, Suppliers, individuals, or entities proposed for those portions of the Work in accordance with the Contract Documents to the Owner's satisfaction within the prescribed time.
- 19.06 If the Contract is to be awarded, Owner will award the Contract to the lowest Bidder whose evaluation by Owner indicates to Owner that the award will be in the best interests of the Project to the lowest responsible, responsive Bidder.
- 19.07 Also, Owner reserves the right to waive all informalities not involving price, time or changes in the Work and to negotiate contract terms with the Successful Bidder. Discrepancies between the multiplication of units of Work and unit prices will be resolved in favor of the unit prices.
- 19.08 Discrepancies between the indicated sum of any column of figures and the correct sum thereof will be resolved in favor of the correct sum. Discrepancies between words and figures will be resolved in favor of the words.
- 19.09 Owner may also consider the operating costs, maintenance requirements, performance data and guarantees of major items of materials and equipment proposed for incorporation in the work when such data is required to be submitted prior to the Notice of Award.

ARTICLE 20 – CONTRACT SECURITY AND INSURANCE

- 20.01 Article 5 of the General Conditions, as may be modified by the Supplementary Conditions, sets forth Owner's requirements as to maintenance bond and insurance. When the Successful

Bidder delivers the executed Agreement to Owner, it shall be accompanied by such bond and insurance.

ARTICLE 21 – SIGNING OF AGREEMENT

21.01 When Owner issues a Notice of Award to the Successful Bidder, it shall be accompanied by the required number of unsigned counterparts of the Agreement along with the other Contract Documents which are identified in the Agreement as attached thereto. Within ten days thereafter, Successful Bidder shall sign and deliver the required number of counterparts of the Agreement and attached documents to Owner. Within ten days thereafter, Owner shall deliver one fully signed counterpart to Successful Bidder with a complete set of the Drawings with appropriate identification.

ARTICLE 22 – SALES AND USE TAXES

22.01 Bidders shall include in their Bids all amounts of taxes imposed by any taxing authority on the sale, purchase or use of materials and equipment covered by this Contract except state sales tax. All taxes of foregoing descriptions shall be paid by Contractor with the exception of state sales tax.

22.02 After awarding of the Contract the Owner shall issue to the successful bidder all documents necessary to prove “Iowa Sales Tax Exemption” status for the project.

22.03 Successful Bidder is subject to payment of Iowa income tax on income from this work in amounts prescribed by law. If successful Bidder is non-Iowa partnership, individual or association, he shall furnish evidence, prior to execution of Contract, that Bond or Securities have been posted with the Iowa State Department of Revenue in the amount required by law

ARTICLE 23 – RETAINAGE

23.01 Provisions concerning Contractor’s rights to deposit securities in lieu of retainage are set forth in the Agreement.

ARTICLE 24 – CONTRACTS TO BE ASSIGNED (NOT REQUIRED)

ARTICLE 25 – PARTNERING (NOT REQUIRED)

ARTICLE 26 – CONTRACT TERMINATION

26.01 Provisions of law, as contained in Chapter 573A of the Code of Iowa, shall apply to and be a part of this Contract. Chapter 573A provides for termination of Contracts for construction of public improvements when construction or work thereon is stopped because of a national emergency. The provisions of Chapter 573A shall be binding upon all parties hereto including Subcontractors and Sureties upon any Bond given or filed in connection therewith.

ARTICLE 27 - PREFERENCE FOR LABOR AND MATERIALS

27.01 By virtue of statutory authority, preference will be given to products and provisions grown and coal produced within the State of Iowa, and to Iowa domestic labor, to the extent lawfully required under Iowa Statutes; provided that the award of Contract will be made to the lowest

Responsible Bidder submitting the lowest Responsible Bid, which shall be determined without regard to State or local law whereby preference is given on factors other than the amount of the Bid.

ARTICLE 28 - PRECONSTRUCTION CONFERENCE

28.01 Following the award of Contract, contractor and its Subcontractors shall attend a Preconstruction Meeting at a time and place designated by Engineer.

ARTICLE 29 - DAMAGES FOR BREACH OF CONTRACT

29.01 In the event of CONTRACTOR'S breach of or failure to perform the contract within the specified period, time being of the essence of this contract, the Contractor shall be liable to the Owner for all reasonable damages arising from the breach or failure to perform. Such reasonable damages shall include, but shall not be limited to, the following:

1. Attorney's fees incurred in responding to the breach.
2. Additional contract management or supervision expenses arising from the breach.
3. Accounting fees and expenses arising from the breach.
4. Damages for loss of or delayed access, and loss of or delayed use of the project.
5. Reasonable costs of the OWNER'S staff time necessary in responding to the breach.
6. Lost or delayed grants or loans applicable to the project.
7. Costs incurred in curing the breach, completing the project or repairing defective work.
8. Additional interest expense.
9. Additional engineering fees and expenses arising from the breach.

ARTICLE 30 - ATTORNEY FEES AND COURT COSTS

30.01 In the event the OWNER commences a legal proceeding against the CONTRACTOR in which the CONTRACTOR is found to have breached this contract, it is agreed that the OWNER shall be entitled to recover from the CONTRACTOR, in addition to all damages awarded, reasonable attorney fees and court costs.

ARTICLE 31 - COURT JURISDICTION

31.01 Any legal proceeding arising under the provisions of this contract shall be within the exclusive jurisdiction of the Iowa District Court in and for said State.

THIS PAGE LEFT BLANK INTENTIONALLY

ARTICLE 1 – BID RECIPIENT

1.01 This Bid is submitted to:

Hardin County Auditor
c/o Drainage Clerk
Hardin County Courthouse
1215 Edgington Avenue, Suite 1
Eldora, Iowa 50627

1.02 The undersigned Bidder proposes and agrees, if this Bid is accepted, to enter into an Agreement with Owner in the form included in the Bidding Documents to perform all Work as specified or indicated in the Bidding Documents for the prices and within the times indicated in this Bid and in accordance with the other terms and conditions of the Bidding Documents.

ARTICLE 2 – BIDDER’S ACKNOWLEDGEMENTS

2.01 Bidder accepts all of the terms and conditions of the Instructions to Bidders, including without limitation those dealing with the disposition of Bid security. This Bid will remain subject to acceptance for 60 days after the Bid opening, or for such longer period of time that Bidder may agree to in writing upon request of Owner.

ARTICLE 3 – BIDDER’S REPRESENTATIONS

3.01 In submitting this Bid, Bidder represents that:

A. Bidder has examined and carefully studied the Bidding Documents, other related data identified in the Bidding Documents, and the following Addenda, receipt of which is hereby acknowledged:

<u>Addendum No.</u>	<u>Addendum Date</u>
_____	_____
_____	_____
_____	_____

B. Bidder has visited the Site and become familiar with and is satisfied as to the general, local, and Site conditions that may affect cost, progress, and performance of the Work.

C. Bidder is familiar with and is satisfied as to all Laws and Regulations that may affect cost, progress, and performance of the Work.

D. Bidder has carefully studied all: (1) all drawings of physical conditions relating to existing surface or subsurface structures at the Site (except Underground Facilities) that have been identified in SC-4.02 as containing reliable "technical data," and (2) reports and drawings of Hazardous Environmental Conditions, if any, at the Site that have been identified in SC-4.06 as containing reliable "technical data."

E. Bidder has considered the information known to Bidder; information commonly known to contractors doing business in the locality of the Site; information and observations obtained from visits to the Site; the Bidding Documents; and the Site-related reports and drawings identified in the Bidding Documents, with respect to the effect of such information, observations, and documents on (1) the cost, progress, and performance of the Work; (2) the

means, methods, techniques, sequences, and procedures of construction to be employed by Bidder (3) Bidder's safety precautions and programs.

- F. Based on the information and observations referred to in Paragraph 3.01.E above, Bidder does not consider that further examinations, investigations, explorations, tests, studies, or data are necessary for the determination of this Bid for performance of the Work at the price(s) bid and within the times required, and in accordance with the other terms and conditions of the Bidding Documents.
- G. Bidder is aware of the general nature of work to be performed by Owner and others at the Site that relates to the Work as indicated in the Bidding Documents.
- H. Bidder has given Engineer written notice of all conflicts, errors, ambiguities, or discrepancies that Bidder has discovered in the Bidding Documents, and the written resolution thereof by Engineer is acceptable to Bidder.
- I. The Bidding Documents are generally sufficient to indicate and convey understanding of all terms and conditions for the performance of the Work for which this Bid is submitted.

ARTICLE 4 – BIDDER'S CERTIFICATION

4.01 Bidder certifies that:

- A. This Bid is genuine and not made in the interest of or on behalf of any undisclosed individual or entity and is not submitted in conformity with any collusive agreement or rules of any group, association, organization, or corporation;
- B. Bidder has not directly or indirectly induced or solicited any other Bidder to submit a false or sham Bid;
- C. Bidder has not solicited or induced any individual or entity to refrain from bidding; and
- D. Bidder has not engaged in corrupt, fraudulent, collusive, or coercive practices in competing for the Contract. For the purposes of this Paragraph 4.01.D:
 - 1. "corrupt practice" means the offering, giving, receiving, or soliciting of anything of value likely to influence the action of a public official in the bidding process;
 - 2. "fraudulent practice" means an intentional misrepresentation of facts made (a) to influence the bidding process to the detriment of Owner, (b) to establish bid prices at artificial non-competitive levels, or (c) to deprive Owner of the benefits of free and open competition;
 - 3. "collusive practice" means a scheme or arrangement between two or more Bidders, with or without the knowledge of Owner, a purpose of which is to establish bid prices at artificial, non-competitive levels; and
 - 4. "coercive practice" means harming or threatening to harm, directly or indirectly, persons or their property to influence their participation in the bidding process or affect the execution of the Contract.

ARTICLE 5 – BASIS OF BID

5.01 Bidder will complete the Work in accordance with the Contract Documents for the following price(s):

NAME OF BIDDER _____

ADDRESS OF BIDDER _____

DD 56 BASE BID – PROPOSAL TO FURNISH ALL LABOR, MATERIALS, AND EQUIPMENT TO PERFORM THE WORK DESCRIBED BELOW FOR THE DIVERSION OF MAIN TILE USING CONCRETE TILE, DRAINAGE DISTRICT 56, HARDIN COUNTY, IOWA INCLUDING PROVIDING A TWO-YEAR MAINTENANCE WARRANTY, PERFORMANCE, AND PAYMENT BONDS. CONTRACTOR TO REVIEW BID ITEM DESCRIPTIONS IN THE DETAILED SPECIFICATIONS.

<u>DD 56 BASE BID</u>					
Item No.	Description	Estimated Quantity	Unit	Unit Price	Extended Price
1	48” Ø RCP Tile	4,634	LF	\$ _____	\$ _____
2	48” Ø CMP Tile Outlet	40	LF	\$ _____	\$ _____
3	72” Junction Structure	2	EA	\$ _____	\$ _____
4	Concrete Collar	3	EA	\$ _____	\$ _____
5	Private Tile Connection	10	EA	\$ _____	\$ _____
6	12” Ø Hickenbottom Intake	1	EA	\$ _____	\$ _____
7	Rip-Rap	50	TN	\$ _____	\$ _____
8	Tile Removal	30	LF	\$ _____	\$ _____
9	Fences	1	LS	\$ _____	\$ _____
10	Road Ditch Grading	2	STA	\$ _____	\$ _____
11	Outlet Shaping	1	LS	\$ _____	\$ _____
12	Dewatering	1	LS	\$ _____	\$ _____
13	Exploratory Excavation	2	HR	\$ _____	\$ _____
14	Bonding	1	LS	\$ _____	\$ _____
15	Seeding	1	LS	\$ _____	\$ _____
16	Seeding Warranty	1	LS	\$ _____	\$ _____
DD 56 BASE BID TOTAL (Bid Items 1 – 16 Inclusive)				\$ _____	\$ _____

DD 56 ALTERNATE BID – PROPOSAL TO FURNISH ALL LABOR, MATERIALS, AND EQUIPMENT TO PERFORM THE WORK DESCRIBED BELOW FOR THE DIVERSION OF MAIN TILE USING POLYPROPYLENE TILE, DRAINAGE DISTRICT 56, HARDIN COUNTY, IOWA INCLUDING PROVIDING A TWO-YEAR MAINTENANCE WARRANTY, PERFORMANCE, AND PAYMENT BONDS. CONTRACTOR TO REVIEW BID ITEM DESCRIPTIONS IN THE DETAILED SPECIFICATIONS.

DD 56 ALTERNATE BID						
Item No.	Description	Estimated Quantity	Unit	Unit Price	Extended Price	
1ALT	48" Ø Polypropylene Tile	4,634	LF	\$	\$	
2ALT	48" Ø CMP Tile Outlet	40	LF	\$	\$	
3ALT	72" Junction Structure	2	EA	\$	\$	
4ALT	Concrete Collar	3	EA	\$	\$	
5ALT	Private Tile Connection	10	EA	\$	\$	
6ALT	12" Ø Hickenbottom Intake	1	EA	\$	\$	
7ALT	Rip-Rap	50	TN	\$	\$	
8ALT	Tile Removal	30	LF	\$	\$	
9ALT	Fences	1	LS	\$	\$	
10ALT	Road Ditch Grading	2	STA	\$	\$	
11ALT	Outlet Shaping	1	LS	\$	\$	
12ALT	Dewatering	1	LS	\$	\$	
13ALT	Exploratory Excavation	2	HR	\$	\$	
14ALT	Bonding	1	LS	\$	\$	
15ALT	Seeding	1	LS	\$	\$	
16ALT	Seeding Warranty	1	LS	\$	\$	

DD 56 ALTERNATE BID TOTAL (Bid Items 1ALT – 16ALT Inclusive) \$ _____

DD 56 ADD ALTERNATES BIDS – PROPOSAL TO FURNISH ALL LABOR, MATERIALS, AND EQUIPMENT TO PERFORM THE ADDITIONAL WORK DESCRIBED BELOW FOR THE DIVERSION OF MAIN TILE, DRAINAGE DISTRICT 56, HARDIN COUNTY, IOWA INCLUDING PROVIDING A TWO-YEAR MAINTENANCE WARRANTY, PERFORMANCE, AND PAYMENT BONDS. CONTRACTOR TO REVIEW BID ITEM DESCRIPTIONS IN THE DETAILED SPECIFICATIONS.

DD 56 ADD ALTERNATES BID						
Item No.	Description	Estimated Quantity	Unit	Unit Price	Extended Price	
1ADD	Mandrel Testing of Tile	4,674	LF	\$	\$	
2ADD	CCTV Inspection of Tile	4,674	LF	\$	\$	
3ADD	Trench Compaction	46.74	STA	\$	\$	
4ADD	Mandrel and CCTV Access Point	4	EA	\$	\$	
5ADD	Additional 2' of Installation Depth	4,674	LF	\$	\$	

Unit Prices have been computed in accordance with Paragraph 11.03.B of the General Conditions and the detailed technical specifications.

Bidder acknowledges that estimated quantities are not guaranteed and are solely for the purpose of comparison of Bids, and final payment for all unit price Bid items will be based on actual quantities, determined as provided in the Contract Documents.

ARTICLE 6 – TIME OF COMPLETION

6.01 Bidder agrees that the Work will be completed on or before the dates stated in the Notice to Contractors Page N-2.

6.02 Bidder accepts the liquidated damage and bonus provisions as stated in the Notice, Page N-2.

ARTICLE 7 – ATTACHMENTS TO THIS BID

7.01 The following documents are submitted with and made a condition of this Bid:

- A. Required Bid security in the form of bond or check;
- B. List of Proposed Subcontractors (to be submitted by apparent low bidder within 48 hours of bid opening);
- C. List of Proposed Suppliers (to be submitted by apparent low bidder within 48 hours of bid opening);
- D. List of Project References (to be submitted by apparent low bidder within 48 hours of bid opening);
- E. Evidence of authority to do business in the state of the Project; or a written covenant to obtain such license within the time for acceptance of Bids;
- F. Contractor's License No.: _____ [or] Evidence of Bidder's ability to obtain a State Contractor's License and a covenant by Bidder to obtain said license within the time for acceptance of Bids;
- G. Required Bidder Qualification Statement with Supporting Data (to be submitted by apparent low bidder within 48 hours of bid opening);

ARTICLE 8 – DEFINED TERMS

8.01 The terms used in this Bid with initial capital letters have the meanings stated in the Instructions to Bidders, the General Conditions, and the Supplementary Conditions.

ARTICLE 9- BID SUBMITTAL

9.01 This Bid is submitted by:

If Bidder is:

An Individual

Name (typed or printed): _____

By: _____
(Individual's signature)

Doing business as: _____

A Partnership

Partnership Name: _____

By: _____
(Signature of general partner -- attach evidence of authority to sign)

Name (typed or printed): _____

A Corporation

Corporation Name: _____
(SEAL)

State of Incorporation: _____
Type (General Business, Professional, Service, Limited Liability): _____

By: _____
(Signature -- attach evidence of authority to sign)

Name (typed or printed): _____

Title: _____
(CORPORATE SEAL)

Attest _____

Date of Qualification to do business in [Iowa] is ____/____/____.

A Joint Venture

Name of Joint Venture: _____

First Joint Venturer Name: _____
(SEAL)

By: _____
(Signature of first joint venture partner -- attach evidence of authority to sign)

Name (typed or printed): _____

Title: _____

Second Joint Venturer Name: _____ (SEAL)

By: _____
(Signature of second joint venture partner -- attach evidence of authority to sign)

Name (typed or printed): _____

Title: _____

(Each joint venturer must sign. The manner of signing for each individual, partnership, and corporation that is a party to the joint venture should be in the manner indicated above.)

Bidder's Business Address _____

Phone No. _____ Fax No. _____

E-mail _____

SUBMITTED on _____, 20____.

State Contractor License No. _____ . *[If applicable]*

THIS PAGE LEFT BLANK INTENTIONALLY

Date: _____

AGREEMENT BETWEEN OWNER AND CONTRACTOR
(This Agreement Supersedes Sample Agreement in Book 2)

THIS AGREEMENT is by and between _____ Hardin County Supervisors acting as Trustees of Drainage
District 56 _____ (“Owner”) and
_____ (“Contractor”).

Owner and Contractor hereby agree as follows:

ARTICLE 1 – WORK

1.01 Contractor shall complete all Work as specified or indicated in the Contract Documents. The Work is generally described as follows:

ARTICLE 2 – THE PROJECT

2.01 The project involves diversion of the Main tile of Drainage District 56, installing new tile and creating a new outlet, Hardin County, Iowa. The final extent of the project work will be determined after bids are received.

ARTICLE 3 – ENGINEER

3.01 The Project has been designed by CGA which is to act as Owner’s representative, assume all duties and responsibilities, and have the rights and authority assigned to Engineer in the Contract Documents in connection with the completion of the Work in accordance with the Contract Documents.

ARTICLE 4 – CONTRACT TIMES

4.01 *Time of the Essence*

A. All time limits for Milestones, if any, Substantial Completion, and completion and readiness for final payment as stated in the Contract Documents are of the essence of the Contract.

4.02 *Dates for Substantial Completion and Final Payment*

A. The Work must be completed by December 31, 2021.

4.03 *Liquidated Damages*

A. Contractor and Owner recognize that time is of the essence as stated in Paragraph 4.01 above and that Owner will suffer financial loss if the Work is not completed within the times specified in Paragraph 4.02 above, plus any extensions thereof allowed in accordance with Article 12 of the General Conditions. The parties also recognize the delays, expense, and difficulties involved in proving in a legal or arbitration proceeding the actual loss suffered by Owner if the Work is not completed on time. Accordingly, instead of requiring any such proof, Owner and Contractor agree that as liquidated damages for delay (but not as a penalty), Contractor shall pay Owner \$500.00 for each day that expires after the time specified in Paragraph 4.02 above for completion.

- B. In the event the Contractor fails to complete the construction within the times specified in Paragraph 4.02 above, and the delay in completion results in additional expense to the Owner for engineering, observation, or construction surveying services, the Contractor shall reimburse the Owner for the additional engineering expense resulting from the delay in the completion of the project. The Owner will withhold from the Contractor's payment, the cost of additional engineering services resulting in the delay of the completion of the project. Such extra engineering costs in no way constitute a penalty, but said costs represent additional expense to the Owner caused by delay in the completion of the project by the Contractor.

ARTICLE 5 – CONTRACT PRICE

- 5.01 Owner shall pay Contractor for completion of the Work in accordance with the Contract Documents an amount in current funds equal to the sum of the amounts determined pursuant to Paragraphs 5.01.A, 5.01.B, and 5.01.C below:

All specific cash allowances are included in the above price in accordance with Paragraph 11.02 of the General Conditions.

- A. For all Unit Price Work, an amount equal to the sum of the established unit price for each separately identified item of Unit Price Work times the actual quantity of that item:

<u>UNIT PRICE WORK</u>						
<u>Item No.</u>	<u>Description</u>	<u>Unit</u>	<u>Estimated Quantity</u>	<u>Bid Unit Price</u>	<u>Bid Price</u>	
Total of all Bid Prices (Unit Price Work)						

The Bid prices for Unit Price Work set forth as of the Effective Date of the Agreement are based on estimated quantities. As provided in Paragraph 11.03 of the General Conditions, estimated quantities are not guaranteed, and determinations of actual quantities and classifications are to be made by Engineer as provided in Paragraph 9.07 of the General Conditions.

- B. For all Work, at the prices stated in Contractor's Bid, attached hereto as an exhibit.

ARTICLE 6 – PAYMENT PROCEDURES

- 6.01 *Submittal and Processing of Payments*

- A. Contractor shall submit Applications for Payment in accordance with Article 14 of the General Conditions. Applications for Payment will be processed by Engineer as provided in the General Conditions.

- 6.02 *Progress Payments; Retainage*

- A. Owner shall make progress payments on account of the Contract Price on the basis of Contractor's Applications for Payment on or about the fourth (4th) Wednesday of each month during performance of the Work as provided in Paragraph 6.02.A.1 below. All such payments will be measured by the schedule of values established as provided in Paragraph 2.07.A of the General Conditions (and in the case of Unit Price Work based on the number of units completed) or, in the event there is no schedule of values, as provided in the General Requirements.

1. Prior to Substantial Completion, progress payments will be made in an amount equal to the percentage indicated below but, in each case, less the aggregate of payments previously made and less such amounts as Engineer may determine or Owner may withhold, including but not limited to liquidated damages, in accordance with Paragraph 14.02 of the General Conditions.
 - a. 90 percent of Work completed (with the balance being retainage). If the Work has been 50 percent completed as determined by Engineer, and if the character and progress of the Work have been satisfactory to Owner and Engineer, then as long as the character and progress of the Work remain satisfactory to Owner and Engineer, there will be no additional retainage; and
 - b. 0 percent of cost of materials and equipment not incorporated in the Work (with the balance being retainage).
 - B. Upon Substantial Completion, Owner shall pay an amount sufficient to increase total payments to Contractor to 90 percent of the Work completed, less such amounts as Engineer shall determine in accordance with Paragraph 14.02.B.5 of the General Conditions and less 200 percent of Engineer's estimate of the value of Work to be completed or corrected as shown on the tentative list of items to be completed or corrected attached to the certificate of Substantial Completion.
- 6.03 *Payment Becomes Due:*
- A. Forty-five (45) days after presentation of the Application for Payment to Owner with Engineer's recommendation, the amount recommended will (subject to the provisions of Paragraph 14.02D) become due, and when due will be paid by the Owner to Contractor.

6.04 *Final Payment*

- A. Upon final completion and acceptance of the Work in accordance with Paragraph 14.07 of the General Conditions, Owner shall pay the remainder of the Contract Price as recommended by Engineer as provided in said Paragraph 14.07.

ARTICLE 7 – INTEREST

- 7.01 All moneys not paid when due as provided in Article 14 of the General Conditions shall bear interest at the rate 2.5 percent per annum computed daily at simple interest.

ARTICLE 8 – CONTRACTOR'S REPRESENTATIONS

- 8.01 In order to induce Owner to enter into this Agreement, Contractor makes the following representations:
- A. Contractor has examined and carefully studied the Contract Documents and the other related data identified in the Bidding Documents.
 - B. Contractor has visited the Site and become familiar with and is satisfied as to the general, local, and Site conditions that may affect cost, progress, and performance of the Work.
 - C. Contractor is familiar with and is satisfied as to all federal, state, and local Laws and Regulations that may affect cost, progress, and performance of the Work.
 - D. Contractor has carefully studied all drawings of physical conditions relating to existing surface or subsurface structures at the Site (except Underground Facilities), if any, that have been identified in Paragraph SC-4.02 of the Supplementary Conditions as containing reliable "technical data,"

- E. Contractor has considered the information known to Contractor; information commonly known to contractors doing business in the locality of the Site; information and observations obtained from visits to the Site; the Contract Documents; and the Site-related reports and drawings identified in the Contract Documents, with respect to the effect of such information, observations, and documents on (1) the cost, progress, and performance of the Work; (2) the means, methods, techniques, sequences, and procedures of construction to be employed by Contractor, including any specific means, methods, techniques, sequences, and procedures of construction expressly required by the Contract Documents; and (3) Contractor's safety precautions and programs.
- F. Based on the information and observations referred to in Paragraph 8.01.E above, Contractor does not consider that further examinations, investigations, explorations, tests, studies, or data are necessary for the performance of the Work at the Contract Price, within the Contract Times, and in accordance with the other terms and conditions of the Contract Documents.
- G. Contractor is aware of the general nature of work to be performed by Owner and others at the Site that relates to the Work as indicated in the Contract Documents.
- H. Contractor has given Engineer written notice of all conflicts, errors, ambiguities, or discrepancies that Contractor has discovered in the Contract Documents, and the written resolution thereof by Engineer is acceptable to Contractor.
- I. The Contract Documents are generally sufficient to indicate and convey understanding of all terms and conditions for performance and furnishing of the Work.

ARTICLE 9 – CONTRACT DOCUMENTS

9.01 Contents

- A. The Contract Documents consist of the following:
 - 1. This Agreement (pages 1 to 7, inclusive, Book 1).
 - 2. General Conditions (pages 1 to 55, inclusive, Book 2).
 - 3. Supplementary Conditions (pages 1 to 9, inclusive, Book 2).
 - 4. Specifications as listed in the table of contents of the Project Manual (Book 1 and Book 2).
 - 5. Detailed Specifications (pages 1 to 6, inclusive, Book 1)
 - 6. Addenda (numbers _____ to _____, inclusive).
 - 7. Construction Plans (Pages A.01-A.02; B.01; and D.01-D.03)
 - 8. Exhibits to this Agreement (enumerated as follows):
 - a. Contractor's Bid (pages 1 to 7, inclusive, Book 1).
 - b. Documentation submitted by Contractor prior to Notice of Award (pages _____ to _____, inclusive).
 - 9. The following which may be delivered or issued on or after the Effective Date of the Agreement and are not attached hereto:

- a. Notice to Proceed (pages _____ to _____, inclusive).
 - b. Work Change Directives.
 - c. Change Orders.
- B. The documents listed in Paragraph 9.01.A are attached to this Agreement (except as expressly noted otherwise above).
- C. There are no Contract Documents other than those listed above in this Article 9.
- D. The Contract Documents may only be amended, modified, or supplemented as provided in Paragraph 3.04 of the General Conditions.

ARTICLE 10 – MISCELLANEOUS

10.01 *Terms*

- A. Terms used in this Agreement will have the meanings stated in the General Conditions and the Supplementary Conditions.

10.02 *Assignment of Contract*

- A. No assignment by a party hereto of any rights under or interests in the Contract will be binding on another party hereto without the written consent of the party sought to be bound; and, specifically but without limitation, moneys that may become due and moneys that are due may not be assigned without such consent (except to the extent that the effect of this restriction may be limited by law), and unless specifically stated to the contrary in any written consent to an assignment, no assignment will release or discharge the assignor from any duty or responsibility under the Contract Documents.

10.03 *Successors and Assigns*

- A. Owner and Contractor each binds itself, its partners, successors, assigns, and legal representatives to the other party hereto, its partners, successors, assigns, and legal representatives in respect to all covenants, agreements, and obligations contained in the Contract Documents.

10.04 *Severability*

- A. Any provision or part of the Contract Documents held to be void or unenforceable under any Law or Regulation shall be deemed stricken, and all remaining provisions shall continue to be valid and binding upon Owner and Contractor, who agree that the Contract Documents shall be reformed to replace such stricken provision or part thereof with a valid and enforceable provision that comes as close as possible to expressing the intention of the stricken provision.

10.05 *Contractor's Certifications*

Contractor certifies that it has not engaged in corrupt, fraudulent, collusive, or coercive practices in competing for or in executing the Contract. For the purposes of this Paragraph 10.05:

1. "corrupt practice" means the offering, giving, receiving, or soliciting of any thing of value likely to influence the action of a public official in the bidding process or in the Contract execution;

2. “fraudulent practice” means an intentional misrepresentation of facts made (a) to influence the bidding process or the execution of the Contract to the detriment of Owner, (b) to establish Bid or Contract prices at artificial non-competitive levels, or (c) to deprive Owner of the benefits of free and open competition;
3. “collusive practice” means a scheme or arrangement between two or more Bidders, with or without the knowledge of Owner, a purpose of which is to establish Bid prices at artificial, non-competitive levels; and
4. “coercive practice” means harming or threatening to harm, directly or indirectly, persons or their property to influence their participation in the bidding process or affect the execution of the Contract.

IN WITNESS WHEREOF, Owner and Contractor have signed this Agreement. Counterparts have been delivered to Owner and Contractor. All portions of the Contract Documents have been signed or have been identified by Owner and Contractor or on their behalf.

This Agreement will be effective on _____ (which is the Effective Date of the Agreement).

OWNER:

CONTRACTOR

By: _____

By: _____

Title: _____

Title: _____

(If Contractor is a corporation, a partnership, or a joint venture, attach evidence of authority to sign.)

Attest: _____

Attest: _____

Title: _____

Title: _____

Address for giving notices:

Address for giving notices:

License No.: _____

(If Owner is a corporation, attach evidence of authority to sign. If Owner is a public body, attach evidence of authority to sign and/or resolution or other documents authorizing execution of this Agreement.)

Agent for service of process:

THIS PAGE LEFT BLANK INTENTIONALLY

DETAILED SPECIFICATIONS

STANDARD SPECIFICATIONS

The Iowa Statewide Urban Design and Specifications (SUDAS), 2021 Edition, where referenced herein shall apply and be referred to as the “Standard Specifications” throughout the detailed specification section.

BID ITEM DESCRIPTIONS

Bid items are described in detail on the proposal, on the plans and below. All work necessary to complete on the project must be incorporated within these items.

48” Ø RCP Tile (Item 1)

This item consists of drainage tile that is RCP (Class IV or V, Wall B) with bell and spigot joints, meeting the requirements of ASTM C76 and SUDAS Section 4020 or Engineer approved equivalent. The unit price shall include, but is not limited to excavation, dewatering, furnishing and placing backfill, materials, installation, furnishing and placing rock backfill and bedding (Type R-2 per SUDAS Figure SW-102), wrapped and sealed pipe joints (per RCP Joint Detail in project plans), testing, by-passing of storm/tile water, inspection, separation of topsoil during excavation operations, and all appurtenances necessary for proper installation.

48” Ø Polypropylene Tile (Item 1ALT)

This item consists of drainage tile that is triple wall polypropylene (minimum stiffness of 45 psi) with gasketed joints meeting the requirements of AASHTO M3300 and ASTM D3212. Tile shall have corrugated exterior and smooth interior, Class 2 perforations, and be or GOLDPRO Storm, or Engineer approved equivalent. The unit price shall include, but is not limited to excavation, dewatering, materials, installation, furnishing and placing rock backfill and bedding (Type F-3 per SUDAS Figure SW-103) testing, by-passing of storm/tile water, inspection, separation of topsoil during excavation operations, bracing necessary to prevent floatation prior to backfilling operations, and all appurtenances necessary for proper installation.

48” Ø CMP Tile Outlet (Items 2 and 2ALT)

These items consist of installing a new tile CMP outlet pipe from the diverted district tile. All outleting will be performed with CMP outlet pipe with aluminized coating (14 gage minimum) meeting the requirements of AASHTO M36 and M274 and ASTM A760 and rodent guard or Engineer approved equivalent. All CMP outlet pipe shall be the same inside diameter as the diverted district tile. The unit price shall include, but is not limited to excavation, dewatering, furnishing and placing backfill, materials, installation, furnishing and placing rock backfill and bedding (Type R-2 per SUDAS Figure SW-102 for RCP tile or Type F-3 per SUDAS Figure SW-103 for polypropylene tile), watertight pipe joints, testing, by-passing of storm/tile water, inspection, separation of topsoil during excavation operations, and all appurtenances necessary for proper installation.

72” Junction Structure (Items 3 and 3ALT)

These junction structures shall meet the requirements of SUDAS Figure SW-401 or Engineer equivalent. The unit price shall include, but is not limited to excavation, dewatering, furnishing and placing backfill, materials, installation, casting (Type 5 per SUDAS Figure SW-604), furnishing and placing rock backfill and bedding (Type R-2 per SUDAS Figure SW-102 for RCP or Type F-3 per

SUDAS Figure SW-103 for Polypropylene tile), testing by-passing of storm/tile water, inspection, separation of topsoil during excavation operations, and all appurtenances necessary for proper installation.

Concrete Collar (Items 4 and 4ALT)

These items consist of concrete collar connections (per Type PC-2 Concrete Collar Connection Detail in project plans) meeting the requirements of SUDAS Section 4020. Said connections shall be used to join dissimilar pipe materials, or adjust horizontal alignment only at location specifically called for on the project plan sheets (in lieu of concrete collars to adjust horizontal alignment, engineer approved factory fittings may be substituted). The unit price shall include, but is not limited to excavation, dewatering, materials, installation, furnishing and placing rock backfill and bedding (Type R-2 per SUDAS Figure SW-102 for RCP tile or Type F-3 per SUDAS Figure SW-103 for polypropylene tile), testing, by-passing of storm/tile water, inspection, separation of topsoil during excavation operations, and all appurtenances necessary for proper installation

Private Tile Connection (Items 5 and 5ALT)

These items consist of unhooking private tile from the existing private tile and connecting it to the diverted main tile (per Private Tile Connection Detail in project plans). All connections will be performed with dual wall, non-perforated HDPE meeting the requirements of AASHTO M252 and SUDAS Section 4020 or Engineer approved equivalent. All connections shall be the same inside diameter (or larger) as the existing private tile. Part of this work shall include excavating far enough upstream on the private tile to allow for proper connection to new HDPE private tile, connecting the existing private tile and the HDPE private tile with a Fern-Co Coupler or a concrete collar (per Type PC-2 Concrete Collar Connection Detail in project plans or Type PC-2 per SUDAS Figure SW-211), and connecting the HDPE private tile to the proposed district tile with factory preformed tee or Engineer approved equivalent. The unit price shall include, but is not limited to excavation, dewatering, materials, installation, furnishing and placing rock backfill and bedding (Type R-2 per SUDAS Figure SW-102 for RCP tile or Type F-3 per SUDAS Figure SW-103 for polypropylene tile), watertight pipe joints, testing, by-passing of storm/tile water, inspection, separation of topsoil during excavation operations, and all appurtenances necessary for proper installation

12" Ø Hickenbottom Intake (Items 6 and 6ALT)

These items consist of HDPE intake or Nyoplast intake with 1-inch holes (including riser), factory preformed HDPE tee (matching the size of the district tile and intake) and necessary HDPE fittings, meeting the requirements of AASHTO M252 or M294 and ASTM F405, 3" clean rock backfill from district tile to ground surface for 1 foot on all sides of intake wrapped with engineering fabric meeting the requirements of IDOT Specifications 4196.01.B.3 and SUDAS Section 9040 or Engineer approved equivalent. The unit price shall include, but is not limited to excavation, dewatering, furnishing and placing backfill, materials, installation, furnishing and placing rock backfill and bedding (Type R-2 per SUDAS Figure SW-102 for RCP tile or Type F-3 per SUDAS Figure SW-103 for polypropylene tile), wrapped pipe joints, testing, by-passing of storm/tile water, inspection, separation of topsoil during excavation operations, and all appurtenances necessary for proper installation.

Riprap (Items 7 and 7ALT)

These items consist of providing and installing geotextile fabric and riprap around upper main tile outlet after shaping to prevent erosion. All riprap shall be IDOT Class E Revetment and shall meet

the requirements of IDOT Specifications 4130 and SUDAS Section 9040. All geotextile fabric shall meet the requirements of IDOT Specifications 4196.01.B.3 and SUDAS Section 9040.

Tile Removal (Items 8 and 8ALT)

These items consist of removing existing tile in accordance with SUDAS Section 4020 or Engineer approved equivalent. The intent is to remove the existing tile, install required tile, and backfill the area with approved compacted backfill. The unit price shall include, but not limited to excavation, dewatering, by-passing of storm/tile water, materials, installation, furnishing and placing backfill, disposal of debris/removed material at contractor-controlled site, testing inspection, and all appurtenances necessary for proper installation. Crushing and burying of tile, intakes, and structures on-site will not be allowed.

Fences (Items 9 and 9ALT)

The Contractor shall be responsible for the removal and replacement of fences that interfere with the work. The Contractor will be required to remove fencing in such a manner as not to damage or weaken the balance of any fencing adjacent to or connected to that portion requiring removal. The Contractor will be required to furnish all salvaged or new materials to restore the removed sections of fencing to their original condition, with all materials and workmanship approved by the Engineer.

Road Ditch Grading (Items 10 and 10ALT)

These items consist of grading and shaping the road ditch (100 feet in each direction) around the proposed Hickenbottom Intake and Intake Junction Structure on the north side of 230th Street to provide positive drainage to each. It also includes grading a berm between said Hickenbottom Intake and Intake Junction Structure to keep surface waters of each separated.

Outlet Shaping (Items 11 and 11ALT)

These items consist of grading a 100 feet diameter area around the upper main tile outlet to prevent erosion.

Dewatering (Items 12 and 12ALT)

These items consist of everything needed to dewater all trenches and excavations to allow for proper tile installation per SUDAS Section 3010 except the following:

- 1) Dewater will be paid for solely under these bid items.
- 2) Contractor shall generate a dewatering plan and submit to the Engineer for review.

Any siltation or erosion caused by the dewatering operations (whether on private property or Drainage District facilities) shall be restored by the Contractor as incidental. No extra payment for the same will be allowed.

Exploratory Excavation (Items 13 and 13ALT)

The location of existing main tile north of 230th Street shown on the plans is approximate. The intent of this item is to cover the contractor's time excavating with a backhoe, operator, and one additional worker to determine the exact location of the existing main tile in the north road ditch of 230th Street. This item shall be paid for worked hours from the time excavation starts until the top of the existing main tile is uncovered. Time spent uncovering the sides to the existing main tile after the top has been uncovered will not be considered exploratory excavation.

Bonding (Items 14 and 14ALT)

These items consists of all bonding costs to be paid to the Contractor if the project is awarded, but does not proceed to construction if the Owner is unable to obtain right of way from landowners and the contract is terminated.

Seeding (Items 15 and 15ALT)

These items consist of permanent seeding for all grassed or pasture areas disturbed in accordance with SUDAS Section 9010 and the Storm Water Pollution Prevention. Permanent seeding mix shall be Type 1 (Permanent Lawn Mixture) per SUDAS Section 9010.

Seeding Warranty (Items 16 and 16ALT)

These items consist of warranty of all seeded areas (items 15 and 15ALT) in accordance with SUDAS Section 9010.3.10.B. The warranty period shall be for 12 months.

Mandrel Testing of Tile (Item 1ADD)

This item consists of deflection testing of the main tile in accordance with SUDAS Section 4060.3.05 or Engineer approved equivalent. The unit price shall include, but is not limited to testing, by-passing of storm/tile water, inspection, removal and replacement of tile exceeding deflection limits, retesting, and all appurtenances necessary for proper testing and installation.

CCTV Inspection of Tile (Item 2ADD)

This item consists of video inspection of the main tile in accordance with SUDAS Section 4060.3.03 or Engineer approved equivalent. The unit price shall include, but is not limited to testing, by-passing of storm/tile water, inspection, and all appurtenances necessary for proper inspection and installation.

Trench Compaction (Item 3ADD)

This item consists of compaction and density/moisture testing of all trenches and excavations in accordance with SUDAS Section 3010.3.05 and 3010.3.06 (including testing as the responsibility of the contractor) or Engineer approved equivalent.

Mandrel and CCTV Access Point (Item 4ADD)

This item consists of 36" or 48" RCP access points that are Class IV or V, Wall B meeting the requirements of ASTM C76, SUDAS Section 4020, SUDAS Figure SW-405 or Engineer approved equivalent. The unit price shall include, but is not limited to excavation, dewatering, furnishing and placing backfill, materials, installation, casting (same as tile) furnishing and placing rock backfill and bedding (per either detail in project plans), testing, by-passing of storm/tile water, inspection, separation of topsoil during excavation operations, and all appurtenances necessary for proper installation.

Additional 2' of Installation Depth (Item 5ADD)

This item consists of installing the proposed main tile at a depth 2' deeper than what is shown on project profile sheets to allow for greater depth on future replacement projects upstream of this project.

CORRECTION PERIOD

Contractor shall warrant the work against defects in materials and installation for a period of two (2) years after the date of acceptance of the repairs by the Owner. Correction shall include, but is not limited to, correction of trench settling, re-seeding, and correction of any eroded areas.

ROADWAY FOR EQUIPMENT

No extra compensation shall be allowed the Contractor for leveling, matting or constructing such roadway as they may deem advisable or necessary to properly carry out the work herein specified. Any temporary driveways or haul roads constructed by the Contractor or suppliers shall be removed and areas restored to original condition by the Contractor at the completion of construction.

ACCESS TO SITE

The Contractor will use existing gates and drives whenever available in getting to and from the various construction locations and along the route of the work. If it is necessary to remove a fence for the passage of equipment or construction, the Contractor will replace said fence to its original state. It is necessary to install a drive for the passage of equipment or construction; the Contractor will remove said drive and return the location to its original state. No extra payment for same will be allowed. All sign posts, mailboxes, or other fixtures removed or damaged during construction shall be replaced in kind. Existing entrances shall be restored using a minimum of four (4) inches of crushed stone.

WORK AREA AND CROP DISTURBANCE

Contractor shall confine all operations to the **300-foot wide strip of right-of-way shown on the project plan sheets** or other right of way shown on the project plans to be staked in the field by the Engineer once it has been obtained by the Owner. **The Contractor shall not order any materials or incur any costs (other than bonding) until the Owner has confirmed that the right of way has been obtained.** If Contractor reaches agreements with private landowners to expand operations beyond said area, written confirmations of and/or actual copies of said agreements will be provided to the Engineer prior to starting construction in said areas. The cost of said expansion and agreements shall be paid by the Contractor and shall be considered incidental. No extra payment for same will be allowed. Contractor shall not disturb any crops during all operations unless directed so by the Engineer. If the Contractor reaches agreements with private landowners to disturb crops, written confirmations of and/or actual copies of said agreements will be provided to the Engineer prior to disturbing said crops. The cost of agreements and crop disturbance on them shall be paid by the Contractor and shall be considered incidental. No extra payment for same will be allowed.

SURFACE RESTORATION (NON PAVED AREAS)

All disturbed areas which are not paved shall be restored in accordance with project plans and the topsoil thickness shall be a minimum of 18-inches. Contractor shall separate, strip/stockpile, or import enough topsoil to conform to this requirement. All costs for said work will be incidental. No extra payment for same will be allowed.

CONTRACTOR QUALIFICATION STATEMENT

If a Bidder has submitted the apparent low bid as read at the bid opening, said Bidder shall be required to submit the "Contractor's Qualification Statement" contained in Book 2 within two calendar days of the bid opening.

WORK DATES

Contractor shall not enter any lands enrolled in the CRP program between May 15th and August 1st, unless waivers from the Franklin County Farm Service Agency are granted to individual landowners.

TELEPHONE PEDESTAL, POWER POLE, AND GUY ANCHOR STABILIZATION

Contractor shall hold, stabilize, remove, replace, and/or relocate telephone pedestals, power poles, and guy anchors during construction (as necessary for proper construction). All work will be done in accordance with the applicable utility company standards. All costs for said work will be incidental. No extra payment for same will be allowed.

EXISTING UTILITIES

1. Some utilities are shown on the project plans. The Contractor shall use the Iowa One-Call Service for the entire project prior to starting any construction to allow review for possible utility conflicts.
2. Where proposed construction shall cross existing utilities (located using Iowa One-Call), Contractor shall locate and expose said utilities at least 24 hours prior to any construction to allow review for possible utility conflicts.
3. No extra payments shall be paid to the contractor for time spent uncovering existing utilities or crossing said utilities with proposed construction. All costs for any work associated with existing utilities will be incidental to the Owner.

SUPPLEMENTARY CONDITIONS REVISIONS

SC-11.03.D.1 in Book 2 of the project specifications is revised to read:

“if the Bid price of a particular item of Unit Price Work amounts to 1 percent or more of the Contract Price and the variation in the quantity of that particular item of Unit Price Work performed by Contractors differs by more than 200 percent from the estimated quantity of such item indicated in the Agreement; and”

MANUFACTURERS CERTIFICATES

Per 1.17 of the Administrative Provisions in Book 2 of the project specifications, the Contractor shall submit Manufacturer’s Certificates for all materials used on this project.

INCIDENTAL WORK

Any work necessary for the proper completion of this project that is not included in the above bid items shall be considered incidental to the project and all costs for said work will be incidental. No extra payment for same will be allowed. Contractor shall notify the Engineer of said work within 24 hours of the Contractor becoming aware of said work.

GENERAL SPECIFICATIONS AND PROJECT FORMS

GENERAL REQUIREMENTS

Standard General Conditions	1 thru 55
Supplementary Conditions to the General Conditions	1 thru 9
Administrative Provisions	1 thru 4
Submittals	1 thru 4
Construction Facilities & Temporary Controls	1 page

PROJECT FORMS

Form of Agreement	1 thru 7
Bid Bond	1 thru 2
Performance Bond	1 thru 3
Payment Bond	1 thru 3
Contractor's Qualification Statement Form	1 thru 3
Subcontractor and Major Material Suppliers List Form	1 Page
Transmittal of Shop Drawings, Equipment Data, Material Samples or Manufacturer's Certificates of Compliance	1 thru 2

(BOOK 2 OF 2)



CLAPSADDLE-GARBER ASSOCIATES OFFICE LOCATIONS

16 East Main Street, PO Box 754 | Marshalltown, IA 50158
1523 S. Bell Avenue, Suite 101 | Ames, IA 50010
5106 Nordic Drive | Cedar Falls, IA 50613
739 Park Avenue | Ackley, IA 50601
511 Bank Street | Webster City, IA 50595

Project Office
739 Park Avenue
Ackley, IA. 50601
Phone: 641-847-3273
Fax: 641-847-2303

This document has important legal consequences; consultation with an attorney is encouraged with respect to its use or modification. This document should be adapted to the particular circumstances of the contemplated Project and the controlling Laws and Regulations.

STANDARD GENERAL CONDITIONS OF THE CONSTRUCTION CONTRACT

Prepared by

ENGINEERS JOINT CONTRACT DOCUMENTS COMMITTEE

and

Issued and Published Jointly by



AMERICAN COUNCIL OF ENGINEERING COMPANIES

ASSOCIATED GENERAL CONTRACTORS OF AMERICA

AMERICAN SOCIETY OF CIVIL ENGINEERS

PROFESSIONAL ENGINEERS IN PRIVATE PRACTICE
A Practice Division of the
NATIONAL SOCIETY OF PROFESSIONAL ENGINEERS

Endorsed by



CONSTRUCTION SPECIFICATIONS INSTITUTE

These General Conditions have been prepared for use with the Suggested Forms of Agreement Between Owner and Contractor (EJCDC C-520 or C-525, 2007 Editions). Their provisions are interrelated and a change in one may necessitate a change in the other. Comments concerning their usage are contained in the Narrative Guide to the EJCDC Construction Documents (EJCDC C-001, 2007 Edition). For guidance in the preparation of Supplementary Conditions, see Guide to the Preparation of Supplementary Conditions (EJCDC C-800, 2007 Edition).

Copyright © 2007 National Society of Professional Engineers
1420 King Street, Alexandria, VA 22314-2794
(703) 684-2882
www.nspe.org

American Council of Engineering Companies
1015 15th Street N.W., Washington, DC 20005
(202) 347-7474
www.acec.org

American Society of Civil Engineers
1801 Alexander Bell Drive, Reston, VA 20191-4400
(800) 548-2723
www.asce.org

Associated General Contractors of America
2300 Wilson Boulevard, Suite 400, Arlington, VA 22201-3308
(703) 548-3118
www.agc.org

The copyright for this EJCDC document is owned jointly by the four EJCDC sponsoring organizations and held in trust for their benefit by NSPE.

**STANDARD GENERAL CONDITIONS OF THE
CONSTRUCTION CONTRACT**

TABLE OF CONTENTS

	Page
Article 1 – Definitions and Terminology	1
1.01 Defined Terms.....	1
1.02 Terminology	4
Article 2 – Preliminary Matters	5
2.01 Delivery of Bonds and Evidence of Insurance	5
2.02 Copies of Documents	6
2.03 Commencement of Contract Times; Notice to Proceed.....	6
2.04 Starting the Work	6
2.05 Before Starting Construction	6
2.06 Preconstruction Conference; Designation of Authorized Representatives	6
2.07 Initial Acceptance of Schedules	7
Article 3 – Contract Documents: Intent, Amending, Reuse	7
3.01 Intent.....	7
3.02 Reference Standards.....	7
3.03 Reporting and Resolving Discrepancies.....	8
3.04 Amending and Supplementing Contract Documents.....	8
3.05 Reuse of Documents	9
3.06 Electronic Data.....	9
Article 4 – Availability of Lands; Subsurface and Physical Conditions; Hazardous Environmental Conditions; Reference Points.....	9
4.01 Availability of Lands.....	9
4.02 Subsurface and Physical Conditions.....	10
4.03 Differing Subsurface or Physical Conditions	10
4.04 Underground Facilities.....	11
4.05 Reference Points.....	12
4.06 Hazardous Environmental Condition at Site	12
Article 5 – Bonds and Insurance.....	14
5.01 Performance, Payment, and Other Bonds.....	14
5.02 Licensed Sureties and Insurers.....	14
5.03 Certificates of Insurance	15
5.04 Contractor’s Insurance	15
5.05 Owner’s Liability Insurance.....	16
5.06 Property Insurance.....	16
5.07 Waiver of Rights	18
5.08 Receipt and Application of Insurance Proceeds	18

5.09	Acceptance of Bonds and Insurance; Option to Replace	19
5.10	Partial Utilization, Acknowledgment of Property Insurer.....	19
Article 6 – Contractor’s Responsibilities		19
6.01	Supervision and Superintendence.....	19
6.02	Labor; Working Hours	19
6.03	Services, Materials, and Equipment	20
6.04	Progress Schedule	20
6.05	Substitutes and “Or-Equals”	20
6.06	Concerning Subcontractors, Suppliers, and Others.....	22
6.07	Patent Fees and Royalties	24
6.08	Permits.....	24
6.09	Laws and Regulations	24
6.10	Taxes	25
6.11	Use of Site and Other Areas.....	25
6.12	Record Documents.....	26
6.13	Safety and Protection	26
6.14	Safety Representative.....	27
6.15	Hazard Communication Programs.....	27
6.16	Emergencies	27
6.17	Shop Drawings and Samples	27
6.18	Continuing the Work.....	29
6.19	Contractor’s General Warranty and Guarantee	29
6.20	Indemnification	29
6.21	Delegation of Professional Design Services.....	30
Article 7 – Other Work at the Site.....		31
7.01	Related Work at Site	31
7.02	Coordination.....	31
7.03	Legal Relationships.....	32
Article 8 – Owner’s Responsibilities.....		32
8.01	Communications to Contractor.....	32
8.02	Replacement of Engineer.....	32
8.03	Furnish Data	32
8.04	Pay When Due.....	32
8.05	Lands and Easements; Reports and Tests.....	32
8.06	Insurance.....	32
8.07	Change Orders.....	33
8.08	Inspections, Tests, and Approvals	33
8.09	Limitations on Owner’s Responsibilities	33
8.10	Undisclosed Hazardous Environmental Condition	33
8.11	Evidence of Financial Arrangements.....	33
8.12	Compliance with Safety Program.....	33
Article 9 – Engineer’s Status During Construction.....		33
9.01	Owner’s Representative	33

9.02	Visits to Site	33
9.03	Project Representative.....	34
9.04	Authorized Variations in Work	34
9.05	Rejecting Defective Work.....	34
9.06	Shop Drawings, Change Orders and Payments	34
9.07	Determinations for Unit Price Work	35
9.08	Decisions on Requirements of Contract Documents and Acceptability of Work	35
9.09	Limitations on Engineer’s Authority and Responsibilities	35
9.10	Compliance with Safety Program	36
Article 10 – Changes in the Work; Claims		36
10.01	Authorized Changes in the Work	36
10.02	Unauthorized Changes in the Work.....	36
10.03	Execution of Change Orders.....	36
10.04	Notification to Surety.....	37
10.05	Claims.....	37
Article 11 – Cost of the Work; Allowances; Unit Price Work		38
11.01	Cost of the Work	38
11.02	Allowances	40
11.03	Unit Price Work	40
Article 12 – Change of Contract Price; Change of Contract Times		41
12.01	Change of Contract Price	41
12.02	Change of Contract Times	42
12.03	Delays	42
Article 13 – Tests and Inspections; Correction, Removal or Acceptance of Defective Work.....		43
13.01	Notice of Defects.....	43
13.02	Access to Work	43
13.03	Tests and Inspections	43
13.04	Uncovering Work.....	44
13.05	Owner May Stop the Work.....	44
13.06	Correction or Removal of Defective Work	44
13.07	Correction Period	45
13.08	Acceptance of Defective Work.....	45
13.09	Owner May Correct Defective Work	46
Article 14 – Payments to Contractor and Completion		46
14.01	Schedule of Values.....	46
14.02	Progress Payments	47
14.03	Contractor’s Warranty of Title.....	49
14.04	Substantial Completion.....	49
14.05	Partial Utilization	50
14.06	Final Inspection	50
14.07	Final Payment.....	51
14.08	Final Completion Delayed	52

14.09 Waiver of Claims	52
Article 15 – Suspension of Work and Termination	52
15.01 Owner May Suspend Work.....	52
15.02 Owner May Terminate for Cause	52
15.03 Owner May Terminate For Convenience	53
15.04 Contractor May Stop Work or Terminate.....	54
Article 16 – Dispute Resolution	54
16.01 Methods and Procedures	54
Article 17 – Miscellaneous	55
17.01 Giving Notice	55
17.02 Computation of Times	55
17.03 Cumulative Remedies	55
17.04 Survival of Obligations	55
17.05 Controlling Law	55
17.06 Headings.....	55

ARTICLE 1 – DEFINITIONS AND TERMINOLOGY

1.01 *Defined Terms*

- A. Wherever used in the Bidding Requirements or Contract Documents and printed with initial capital letters, the terms listed below will have the meanings indicated which are applicable to both the singular and plural thereof. In addition to terms specifically defined, terms with initial capital letters in the Contract Documents include references to identified articles and paragraphs, and the titles of other documents or forms.
1. *Addenda*—Written or graphic instruments issued prior to the opening of Bids which clarify, correct, or change the Bidding Requirements or the proposed Contract Documents.
 2. *Agreement*—The written instrument which is evidence of the agreement between Owner and Contractor covering the Work.
 3. *Application for Payment*—The form acceptable to Engineer which is to be used by Contractor during the course of the Work in requesting progress or final payments and which is to be accompanied by such supporting documentation as is required by the Contract Documents.
 4. *Asbestos*—Any material that contains more than one percent asbestos and is friable or is releasing asbestos fibers into the air above current action levels established by the United States Occupational Safety and Health Administration.
 5. *Bid*—The offer or proposal of a Bidder submitted on the prescribed form setting forth the prices for the Work to be performed.
 6. *Bidder*—The individual or entity who submits a Bid directly to Owner.
 7. *Bidding Documents*—The Bidding Requirements and the proposed Contract Documents (including all Addenda).
 8. *Bidding Requirements*—The advertisement or invitation to bid, Instructions to Bidders, Bid security of acceptable form, if any, and the Bid Form with any supplements.
 9. *Change Order*—A document recommended by Engineer which is signed by Contractor and Owner and authorizes an addition, deletion, or revision in the Work or an adjustment in the Contract Price or the Contract Times, issued on or after the Effective Date of the Agreement.
 10. *Claim*—A demand or assertion by Owner or Contractor seeking an adjustment of Contract Price or Contract Times, or both, or other relief with respect to the terms of the Contract. A demand for money or services by a third party is not a Claim.
 11. *Contract*—The entire and integrated written agreement between the Owner and Contractor concerning the Work. The Contract supersedes prior negotiations, representations, or agreements, whether written or oral.
 12. *Contract Documents*—Those items so designated in the Agreement. Only printed or hard copies of the items listed in the Agreement are Contract Documents. Approved Shop Drawings, other Contractor submittals, and the reports and drawings of subsurface and physical conditions are not Contract Documents.

13. *Contract Price*—The moneys payable by Owner to Contractor for completion of the Work in accordance with the Contract Documents as stated in the Agreement (subject to the provisions of Paragraph 11.03 in the case of Unit Price Work).
14. *Contract Times*—The number of days or the dates stated in the Agreement to: (i) achieve Milestones, if any; (ii) achieve Substantial Completion; and (iii) complete the Work so that it is ready for final payment as evidenced by Engineer's written recommendation of final payment.
15. *Contractor*—The individual or entity with whom Owner has entered into the Agreement.
16. *Cost of the Work*—See Paragraph 11.01 for definition.
17. *Drawings*—That part of the Contract Documents prepared or approved by Engineer which graphically shows the scope, extent, and character of the Work to be performed by Contractor. Shop Drawings and other Contractor submittals are not Drawings as so defined.
18. *Effective Date of the Agreement*—The date indicated in the Agreement on which it becomes effective, but if no such date is indicated, it means the date on which the Agreement is signed and delivered by the last of the two parties to sign and deliver.
19. *Engineer*—The individual or entity named as such in the Agreement.
20. *Field Order*—A written order issued by Engineer which requires minor changes in the Work but which does not involve a change in the Contract Price or the Contract Times.
21. *General Requirements*—Sections of Division 1 of the Specifications.
22. *Hazardous Environmental Condition*—The presence at the Site of Asbestos, PCBs, Petroleum, Hazardous Waste, or Radioactive Material in such quantities or circumstances that may present a substantial danger to persons or property exposed thereto.
23. *Hazardous Waste*—The term Hazardous Waste shall have the meaning provided in Section 1004 of the Solid Waste Disposal Act (42 USC Section 6903) as amended from time to time.
24. *Laws and Regulations; Laws or Regulations*—Any and all applicable laws, rules, regulations, ordinances, codes, and orders of any and all governmental bodies, agencies, authorities, and courts having jurisdiction.
25. *Liens*—Charges, security interests, or encumbrances upon Project funds, real property, or personal property.
26. *Milestone*—A principal event specified in the Contract Documents relating to an intermediate completion date or time prior to Substantial Completion of all the Work.
27. *Notice of Award*—The written notice by Owner to the Successful Bidder stating that upon timely compliance by the Successful Bidder with the conditions precedent listed therein, Owner will sign and deliver the Agreement.
28. *Notice to Proceed*—A written notice given by Owner to Contractor fixing the date on which the Contract Times will commence to run and on which Contractor shall start to perform the Work under the Contract Documents.

29. *Owner*—The individual or entity with whom Contractor has entered into the Agreement and for whom the Work is to be performed.
30. *PCBs*—Polychlorinated biphenyls.
31. *Petroleum*—Petroleum, including crude oil or any fraction thereof which is liquid at standard conditions of temperature and pressure (60 degrees Fahrenheit and 14.7 pounds per square inch absolute), such as oil, petroleum, fuel oil, oil sludge, oil refuse, gasoline, kerosene, and oil mixed with other non-Hazardous Waste and crude oils.
32. *Progress Schedule*—A schedule, prepared and maintained by Contractor, describing the sequence and duration of the activities comprising the Contractor's plan to accomplish the Work within the Contract Times.
33. *Project*—The total construction of which the Work to be performed under the Contract Documents may be the whole, or a part.
34. *Project Manual*—The bound documentary information prepared for bidding and constructing the Work. A listing of the contents of the Project Manual, which may be bound in one or more volumes, is contained in the table(s) of contents.
35. *Radioactive Material*—Source, special nuclear, or byproduct material as defined by the Atomic Energy Act of 1954 (42 USC Section 2011 et seq.) as amended from time to time.
36. *Resident Project Representative*—The authorized representative of Engineer who may be assigned to the Site or any part thereof.
37. *Samples*—Physical examples of materials, equipment, or workmanship that are representative of some portion of the Work and which establish the standards by which such portion of the Work will be judged.
38. *Schedule of Submittals*—A schedule, prepared and maintained by Contractor, of required submittals and the time requirements to support scheduled performance of related construction activities.
39. *Schedule of Values*—A schedule, prepared and maintained by Contractor, allocating portions of the Contract Price to various portions of the Work and used as the basis for reviewing Contractor's Applications for Payment.
40. *Shop Drawings*—All drawings, diagrams, illustrations, schedules, and other data or information which are specifically prepared or assembled by or for Contractor and submitted by Contractor to illustrate some portion of the Work.
41. *Site*—Lands or areas indicated in the Contract Documents as being furnished by Owner upon which the Work is to be performed, including rights-of-way and easements for access thereto, and such other lands furnished by Owner which are designated for the use of Contractor.
42. *Specifications*—That part of the Contract Documents consisting of written requirements for materials, equipment, systems, standards and workmanship as applied to the Work, and certain administrative requirements and procedural matters applicable thereto.
43. *Subcontractor*—An individual or entity having a direct contract with Contractor or with any other Subcontractor for the performance of a part of the Work at the Site.

44. *Substantial Completion*—The time at which the Work (or a specified part thereof) has progressed to the point where, in the opinion of Engineer, the Work (or a specified part thereof) is sufficiently complete, in accordance with the Contract Documents, so that the Work (or a specified part thereof) can be utilized for the purposes for which it is intended. The terms “substantially complete” and “substantially completed” as applied to all or part of the Work refer to Substantial Completion thereof.
45. *Successful Bidder*—The Bidder submitting a responsive Bid to whom Owner makes an award.
46. *Supplementary Conditions*—That part of the Contract Documents which amends or supplements these General Conditions.
47. *Supplier*—A manufacturer, fabricator, supplier, distributor, materialman, or vendor having a direct contract with Contractor or with any Subcontractor to furnish materials or equipment to be incorporated in the Work by Contractor or Subcontractor.
48. *Underground Facilities*—All underground pipelines, conduits, ducts, cables, wires, manholes, vaults, tanks, tunnels, or other such facilities or attachments, and any encasements containing such facilities, including those that convey electricity, gases, steam, liquid petroleum products, telephone or other communications, cable television, water, wastewater, storm water, other liquids or chemicals, or traffic or other control systems.
49. *Unit Price Work*—Work to be paid for on the basis of unit prices.
50. *Work*—The entire construction or the various separately identifiable parts thereof required to be provided under the Contract Documents. Work includes and is the result of performing or providing all labor, services, and documentation necessary to produce such construction, and furnishing, installing, and incorporating all materials and equipment into such construction, all as required by the Contract Documents.
51. *Work Change Directive*—A written statement to Contractor issued on or after the Effective Date of the Agreement and signed by Owner and recommended by Engineer ordering an addition, deletion, or revision in the Work, or responding to differing or unforeseen subsurface or physical conditions under which the Work is to be performed or to emergencies. A Work Change Directive will not change the Contract Price or the Contract Times but is evidence that the parties expect that the change ordered or documented by a Work Change Directive will be incorporated in a subsequently issued Change Order following negotiations by the parties as to its effect, if any, on the Contract Price or Contract Times.

1.02 Terminology

- A. The words and terms discussed in Paragraph 1.02.B through F are not defined but, when used in the Bidding Requirements or Contract Documents, have the indicated meaning.
- B. *Intent of Certain Terms or Adjectives:*
 1. The Contract Documents include the terms “as allowed,” “as approved,” “as ordered,” “as directed” or terms of like effect or import to authorize an exercise of professional judgment by Engineer. In addition, the adjectives “reasonable,” “suitable,” “acceptable,” “proper,” “satisfactory,” or adjectives of like effect or import are used to describe an action or determination of Engineer as to the Work. It is intended that such exercise of professional judgment, action, or determination will be solely to evaluate, in general, the Work for compliance with the information in the Contract Documents and

with the design concept of the Project as a functioning whole as shown or indicated in the Contract Documents (unless there is a specific statement indicating otherwise). The use of any such term or adjective is not intended to and shall not be effective to assign to Engineer any duty or authority to supervise or direct the performance of the Work, or any duty or authority to undertake responsibility contrary to the provisions of Paragraph 9.09 or any other provision of the Contract Documents.

C. *Day:*

1. The word “day” means a calendar day of 24 hours measured from midnight to the next midnight.

D. *Defective:*

1. The word “defective,” when modifying the word “Work,” refers to Work that is unsatisfactory, faulty, or deficient in that it:
 - a. does not conform to the Contract Documents; or
 - b. does not meet the requirements of any applicable inspection, reference standard, test, or approval referred to in the Contract Documents; or
 - c. has been damaged prior to Engineer’s recommendation of final payment (unless responsibility for the protection thereof has been assumed by Owner at Substantial Completion in accordance with Paragraph 14.04 or 14.05).

E. *Furnish, Install, Perform, Provide:*

1. The word “furnish,” when used in connection with services, materials, or equipment, shall mean to supply and deliver said services, materials, or equipment to the Site (or some other specified location) ready for use or installation and in usable or operable condition.
2. The word “install,” when used in connection with services, materials, or equipment, shall mean to put into use or place in final position said services, materials, or equipment complete and ready for intended use.
3. The words “perform” or “provide,” when used in connection with services, materials, or equipment, shall mean to furnish and install said services, materials, or equipment complete and ready for intended use.
4. When “furnish,” “install,” “perform,” or “provide” is not used in connection with services, materials, or equipment in a context clearly requiring an obligation of Contractor, “provide” is implied.

- F. Unless stated otherwise in the Contract Documents, words or phrases that have a well-known technical or construction industry or trade meaning are used in the Contract Documents in accordance with such recognized meaning.

ARTICLE 2 – PRELIMINARY MATTERS

2.01 Delivery of Bonds and Evidence of Insurance

- A. When Contractor delivers the executed counterparts of the Agreement to Owner, Contractor shall also deliver to Owner such bonds as Contractor may be required to furnish.

- B. *Evidence of Insurance:* Before any Work at the Site is started, Contractor and Owner shall each deliver to the other, with copies to each additional insured identified in the Supplementary Conditions, certificates of insurance (and other evidence of insurance which either of them or any additional insured may reasonably request) which Contractor and Owner respectively are required to purchase and maintain in accordance with Article 5.

2.02 *Copies of Documents*

- A. Owner shall furnish to Contractor up to ten printed or hard copies of the Drawings and Project Manual. Additional copies will be furnished upon request at the cost of reproduction.

2.03 *Commencement of Contract Times; Notice to Proceed*

- A. The Contract Times will commence to run on the thirtieth day after the Effective Date of the Agreement or, if a Notice to Proceed is given, on the day indicated in the Notice to Proceed. A Notice to Proceed may be given at any time within 30 days after the Effective Date of the Agreement. In no event will the Contract Times commence to run later than the sixtieth day after the day of Bid opening or the thirtieth day after the Effective Date of the Agreement, whichever date is earlier.

2.04 *Starting the Work*

- A. Contractor shall start to perform the Work on the date when the Contract Times commence to run. No Work shall be done at the Site prior to the date on which the Contract Times commence to run.

2.05 *Before Starting Construction*

- A. *Preliminary Schedules:* Within 10 days after the Effective Date of the Agreement (unless otherwise specified in the General Requirements), Contractor shall submit to Engineer for timely review:
 1. a preliminary Progress Schedule indicating the times (numbers of days or dates) for starting and completing the various stages of the Work, including any Milestones specified in the Contract Documents;
 2. a preliminary Schedule of Submittals; and
 3. a preliminary Schedule of Values for all of the Work which includes quantities and prices of items which when added together equal the Contract Price and subdivides the Work into component parts in sufficient detail to serve as the basis for progress payments during performance of the Work. Such prices will include an appropriate amount of overhead and profit applicable to each item of Work.

2.06 *Preconstruction Conference; Designation of Authorized Representatives*

- A. Before any Work at the Site is started, a conference attended by Owner, Contractor, Engineer, and others as appropriate will be held to establish a working understanding among the parties as to the Work and to discuss the schedules referred to in Paragraph 2.05.A, procedures for handling Shop Drawings and other submittals, processing Applications for Payment, and maintaining required records.
- B. At this conference Owner and Contractor each shall designate, in writing, a specific individual to act as its authorized representative with respect to the services and responsibilities under the Contract. Such individuals shall have the authority to transmit instructions, receive information, render decisions relative to the Contract, and otherwise act on behalf of each respective party.

2.07 *Initial Acceptance of Schedules*

- A. At least 10 days before submission of the first Application for Payment a conference attended by Contractor, Engineer, and others as appropriate will be held to review for acceptability to Engineer as provided below the schedules submitted in accordance with Paragraph 2.05.A. Contractor shall have an additional 10 days to make corrections and adjustments and to complete and resubmit the schedules. No progress payment shall be made to Contractor until acceptable schedules are submitted to Engineer.
 - 1. The Progress Schedule will be acceptable to Engineer if it provides an orderly progression of the Work to completion within the Contract Times. Such acceptance will not impose on Engineer responsibility for the Progress Schedule, for sequencing, scheduling, or progress of the Work, nor interfere with or relieve Contractor from Contractor's full responsibility therefor.
 - 2. Contractor's Schedule of Submittals will be acceptable to Engineer if it provides a workable arrangement for reviewing and processing the required submittals.
 - 3. Contractor's Schedule of Values will be acceptable to Engineer as to form and substance if it provides a reasonable allocation of the Contract Price to component parts of the Work.

ARTICLE 3 – CONTRACT DOCUMENTS: INTENT, AMENDING, REUSE

3.01 *Intent*

- A. The Contract Documents are complementary; what is required by one is as binding as if required by all.
- B. It is the intent of the Contract Documents to describe a functionally complete project (or part thereof) to be constructed in accordance with the Contract Documents. Any labor, documentation, services, materials, or equipment that reasonably may be inferred from the Contract Documents or from prevailing custom or trade usage as being required to produce the indicated result will be provided whether or not specifically called for, at no additional cost to Owner.
- C. Clarifications and interpretations of the Contract Documents shall be issued by Engineer as provided in Article 9.

3.02 *Reference Standards*

- A. Standards, Specifications, Codes, Laws, and Regulations
 - 1. Reference to standards, specifications, manuals, or codes of any technical society, organization, or association, or to Laws or Regulations, whether such reference be specific or by implication, shall mean the standard, specification, manual, code, or Laws or Regulations in effect at the time of opening of Bids (or on the Effective Date of the Agreement if there were no Bids), except as may be otherwise specifically stated in the Contract Documents.
 - 2. No provision of any such standard, specification, manual, or code, or any instruction of a Supplier, shall be effective to change the duties or responsibilities of Owner, Contractor, or Engineer, or any of their subcontractors, consultants, agents, or employees, from those set forth in the Contract Documents. No such provision or instruction shall be effective to assign to Owner, Engineer, or any of their officers, directors, members, partners, employees, agents, consultants, or subcontractors, any duty or authority to supervise or direct the performance of the Work or any duty or authority to undertake responsibility inconsistent with the provisions of the Contract Documents.

3.03 *Reporting and Resolving Discrepancies*

A. *Reporting Discrepancies:*

1. *Contractor's Review of Contract Documents Before Starting Work:* Before undertaking each part of the Work, Contractor shall carefully study and compare the Contract Documents and check and verify pertinent figures therein and all applicable field measurements. Contractor shall promptly report in writing to Engineer any conflict, error, ambiguity, or discrepancy which Contractor discovers, or has actual knowledge of, and shall obtain a written interpretation or clarification from Engineer before proceeding with any Work affected thereby.
2. *Contractor's Review of Contract Documents During Performance of Work:* If, during the performance of the Work, Contractor discovers any conflict, error, ambiguity, or discrepancy within the Contract Documents, or between the Contract Documents and (a) any applicable Law or Regulation, (b) any standard, specification, manual, or code, or (c) any instruction of any Supplier, then Contractor shall promptly report it to Engineer in writing. Contractor shall not proceed with the Work affected thereby (except in an emergency as required by Paragraph 6.16.A) until an amendment or supplement to the Contract Documents has been issued by one of the methods indicated in Paragraph 3.04.
3. Contractor shall not be liable to Owner or Engineer for failure to report any conflict, error, ambiguity, or discrepancy in the Contract Documents unless Contractor had actual knowledge thereof.

B. *Resolving Discrepancies:*

1. Except as may be otherwise specifically stated in the Contract Documents, the provisions of the Contract Documents shall take precedence in resolving any conflict, error, ambiguity, or discrepancy between the provisions of the Contract Documents and:
 - a. the provisions of any standard, specification, manual, or code, or the instruction of any Supplier (whether or not specifically incorporated by reference in the Contract Documents); or
 - b. the provisions of any Laws or Regulations applicable to the performance of the Work (unless such an interpretation of the provisions of the Contract Documents would result in violation of such Law or Regulation).

3.04 *Amending and Supplementing Contract Documents*

- A. The Contract Documents may be amended to provide for additions, deletions, and revisions in the Work or to modify the terms and conditions thereof by either a Change Order or a Work Change Directive.
- B. The requirements of the Contract Documents may be supplemented, and minor variations and deviations in the Work may be authorized, by one or more of the following ways:
 1. A Field Order;
 2. Engineer's approval of a Shop Drawing or Sample (subject to the provisions of Paragraph 6.17.D.3); or
 3. Engineer's written interpretation or clarification.

3.05 *Reuse of Documents*

- A. Contractor and any Subcontractor or Supplier shall not:
1. have or acquire any title to or ownership rights in any of the Drawings, Specifications, or other documents (or copies of any thereof) prepared by or bearing the seal of Engineer or its consultants, including electronic media editions; or
 2. reuse any such Drawings, Specifications, other documents, or copies thereof on extensions of the Project or any other project without written consent of Owner and Engineer and specific written verification or adaptation by Engineer.
- B. The prohibitions of this Paragraph 3.05 will survive final payment, or termination of the Contract. Nothing herein shall preclude Contractor from retaining copies of the Contract Documents for record purposes.

3.06 *Electronic Data*

- A. Unless otherwise stated in the Supplementary Conditions, the data furnished by Owner or Engineer to Contractor, or by Contractor to Owner or Engineer, that may be relied upon are limited to the printed copies (also known as hard copies). Files in electronic media format of text, data, graphics, or other types are furnished only for the convenience of the receiving party. Any conclusion or information obtained or derived from such electronic files will be at the user's sole risk. If there is a discrepancy between the electronic files and the hard copies, the hard copies govern.
- B. Because data stored in electronic media format can deteriorate or be modified inadvertently or otherwise without authorization of the data's creator, the party receiving electronic files agrees that it will perform acceptance tests or procedures within 60 days, after which the receiving party shall be deemed to have accepted the data thus transferred. Any errors detected within the 60-day acceptance period will be corrected by the transferring party.
- C. When transferring documents in electronic media format, the transferring party makes no representations as to long term compatibility, usability, or readability of documents resulting from the use of software application packages, operating systems, or computer hardware differing from those used by the data's creator.

ARTICLE 4 – AVAILABILITY OF LANDS; SUBSURFACE AND PHYSICAL CONDITIONS; HAZARDOUS ENVIRONMENTAL CONDITIONS; REFERENCE POINTS

4.01 *Availability of Lands*

- A. Owner shall furnish the Site. Owner shall notify Contractor of any encumbrances or restrictions not of general application but specifically related to use of the Site with which Contractor must comply in performing the Work. Owner will obtain in a timely manner and pay for easements for permanent structures or permanent changes in existing facilities. If Contractor and Owner are unable to agree on entitlement to or on the amount or extent, if any, of any adjustment in the Contract Price or Contract Times, or both, as a result of any delay in Owner's furnishing the Site or a part thereof, Contractor may make a Claim therefor as provided in Paragraph 10.05.
- B. Upon reasonable written request, Owner shall furnish Contractor with a current statement of record legal title and legal description of the lands upon which the Work is to be performed and Owner's interest

therein as necessary for giving notice of or filing a mechanic's or construction lien against such lands in accordance with applicable Laws and Regulations.

- C. Contractor shall provide for all additional lands and access thereto that may be required for temporary construction facilities or storage of materials and equipment.

4.02 *Subsurface and Physical Conditions*

A. *Reports and Drawings:* The Supplementary Conditions identify:

1. those reports known to Owner of explorations and tests of subsurface conditions at or contiguous to the Site; and
2. those drawings known to Owner of physical conditions relating to existing surface or subsurface structures at the Site (except Underground Facilities).

B. *Limited Reliance by Contractor on Technical Data Authorized:* Contractor may rely upon the accuracy of the "technical data" contained in such reports and drawings, but such reports and drawings are not Contract Documents. Such "technical data" is identified in the Supplementary Conditions. Except for such reliance on such "technical data," Contractor may not rely upon or make any claim against Owner or Engineer, or any of their officers, directors, members, partners, employees, agents, consultants, or subcontractors with respect to:

1. the completeness of such reports and drawings for Contractor's purposes, including, but not limited to, any aspects of the means, methods, techniques, sequences, and procedures of construction to be employed by Contractor, and safety precautions and programs incident thereto; or
2. other data, interpretations, opinions, and information contained in such reports or shown or indicated in such drawings; or
3. any Contractor interpretation of or conclusion drawn from any "technical data" or any such other data, interpretations, opinions, or information.

4.03 *Differing Subsurface or Physical Conditions*

A. *Notice:* If Contractor believes that any subsurface or physical condition that is uncovered or revealed either:

1. is of such a nature as to establish that any "technical data" on which Contractor is entitled to rely as provided in Paragraph 4.02 is materially inaccurate; or
2. is of such a nature as to require a change in the Contract Documents; or
3. differs materially from that shown or indicated in the Contract Documents; or
4. is of an unusual nature, and differs materially from conditions ordinarily encountered and generally recognized as inherent in work of the character provided for in the Contract Documents;

then Contractor shall, promptly after becoming aware thereof and before further disturbing the subsurface or physical conditions or performing any Work in connection therewith (except in an emergency as required by Paragraph 6.16.A), notify Owner and Engineer in writing about such condition. Contractor

shall not further disturb such condition or perform any Work in connection therewith (except as aforesaid) until receipt of written order to do so.

B. *Engineer's Review:* After receipt of written notice as required by Paragraph 4.03.A, Engineer will promptly review the pertinent condition, determine the necessity of Owner's obtaining additional exploration or tests with respect thereto, and advise Owner in writing (with a copy to Contractor) of Engineer's findings and conclusions.

C. *Possible Price and Times Adjustments:*

1. The Contract Price or the Contract Times, or both, will be equitably adjusted to the extent that the existence of such differing subsurface or physical condition causes an increase or decrease in Contractor's cost of, or time required for, performance of the Work; subject, however, to the following:
 - a. such condition must meet any one or more of the categories described in Paragraph 4.03.A; and
 - b. with respect to Work that is paid for on a unit price basis, any adjustment in Contract Price will be subject to the provisions of Paragraphs 9.07 and 11.03.
2. Contractor shall not be entitled to any adjustment in the Contract Price or Contract Times if:
 - a. Contractor knew of the existence of such conditions at the time Contractor made a final commitment to Owner with respect to Contract Price and Contract Times by the submission of a Bid or becoming bound under a negotiated contract; or
 - b. the existence of such condition could reasonably have been discovered or revealed as a result of any examination, investigation, exploration, test, or study of the Site and contiguous areas required by the Bidding Requirements or Contract Documents to be conducted by or for Contractor prior to Contractor's making such final commitment; or
 - c. Contractor failed to give the written notice as required by Paragraph 4.03.A.
3. If Owner and Contractor are unable to agree on entitlement to or on the amount or extent, if any, of any adjustment in the Contract Price or Contract Times, or both, a Claim may be made therefor as provided in Paragraph 10.05. However, neither Owner or Engineer, or any of their officers, directors, members, partners, employees, agents, consultants, or subcontractors shall be liable to Contractor for any claims, costs, losses, or damages (including but not limited to all fees and charges of engineers, architects, attorneys, and other professionals and all court or arbitration or other dispute resolution costs) sustained by Contractor on or in connection with any other project or anticipated project.

4.04 *Underground Facilities*

A. *Shown or Indicated:* The information and data shown or indicated in the Contract Documents with respect to existing Underground Facilities at or contiguous to the Site is based on information and data furnished to Owner or Engineer by the owners of such Underground Facilities, including Owner, or by others. Unless it is otherwise expressly provided in the Supplementary Conditions:

1. Owner and Engineer shall not be responsible for the accuracy or completeness of any such information or data provided by others; and

2. the cost of all of the following will be included in the Contract Price, and Contractor shall have full responsibility for:
 - a. reviewing and checking all such information and data;
 - b. locating all Underground Facilities shown or indicated in the Contract Documents;
 - c. coordination of the Work with the owners of such Underground Facilities, including Owner, during construction; and
 - d. the safety and protection of all such Underground Facilities and repairing any damage thereto resulting from the Work.

B. *Not Shown or Indicated:*

1. If an Underground Facility is uncovered or revealed at or contiguous to the Site which was not shown or indicated, or not shown or indicated with reasonable accuracy in the Contract Documents, Contractor shall, promptly after becoming aware thereof and before further disturbing conditions affected thereby or performing any Work in connection therewith (except in an emergency as required by Paragraph 6.16.A), identify the owner of such Underground Facility and give written notice to that owner and to Owner and Engineer. Engineer will promptly review the Underground Facility and determine the extent, if any, to which a change is required in the Contract Documents to reflect and document the consequences of the existence or location of the Underground Facility. During such time, Contractor shall be responsible for the safety and protection of such Underground Facility.
2. If Engineer concludes that a change in the Contract Documents is required, a Work Change Directive or a Change Order will be issued to reflect and document such consequences. An equitable adjustment shall be made in the Contract Price or Contract Times, or both, to the extent that they are attributable to the existence or location of any Underground Facility that was not shown or indicated or not shown or indicated with reasonable accuracy in the Contract Documents and that Contractor did not know of and could not reasonably have been expected to be aware of or to have anticipated. If Owner and Contractor are unable to agree on entitlement to or on the amount or extent, if any, of any such adjustment in Contract Price or Contract Times, Owner or Contractor may make a Claim therefor as provided in Paragraph 10.05.

4.05 *Reference Points*

- A. Owner shall provide engineering surveys to establish reference points for construction which in Engineer's judgment are necessary to enable Contractor to proceed with the Work. Contractor shall be responsible for laying out the Work, shall protect and preserve the established reference points and property monuments, and shall make no changes or relocations without the prior written approval of Owner. Contractor shall report to Engineer whenever any reference point or property monument is lost or destroyed or requires relocation because of necessary changes in grades or locations, and shall be responsible for the accurate replacement or relocation of such reference points or property monuments by professionally qualified personnel.

4.06 *Hazardous Environmental Condition at Site*

- A. *Reports and Drawings:* The Supplementary Conditions identify those reports and drawings known to Owner relating to Hazardous Environmental Conditions that have been identified at the Site.

- B. *Limited Reliance by Contractor on Technical Data Authorized:* Contractor may rely upon the accuracy of the “technical data” contained in such reports and drawings, but such reports and drawings are not Contract Documents. Such “technical data” is identified in the Supplementary Conditions. Except for such reliance on such “technical data,” Contractor may not rely upon or make any claim against Owner or Engineer, or any of their officers, directors, members, partners, employees, agents, consultants, or subcontractors with respect to:
1. the completeness of such reports and drawings for Contractor’s purposes, including, but not limited to, any aspects of the means, methods, techniques, sequences and procedures of construction to be employed by Contractor and safety precautions and programs incident thereto; or
 2. other data, interpretations, opinions and information contained in such reports or shown or indicated in such drawings; or
 3. any Contractor interpretation of or conclusion drawn from any “technical data” or any such other data, interpretations, opinions or information.
- C. Contractor shall not be responsible for any Hazardous Environmental Condition uncovered or revealed at the Site which was not shown or indicated in Drawings or Specifications or identified in the Contract Documents to be within the scope of the Work. Contractor shall be responsible for a Hazardous Environmental Condition created with any materials brought to the Site by Contractor, Subcontractors, Suppliers, or anyone else for whom Contractor is responsible.
- D. If Contractor encounters a Hazardous Environmental Condition or if Contractor or anyone for whom Contractor is responsible creates a Hazardous Environmental Condition, Contractor shall immediately: (i) secure or otherwise isolate such condition; (ii) stop all Work in connection with such condition and in any area affected thereby (except in an emergency as required by Paragraph 6.16.A); and (iii) notify Owner and Engineer (and promptly thereafter confirm such notice in writing). Owner shall promptly consult with Engineer concerning the necessity for Owner to retain a qualified expert to evaluate such condition or take corrective action, if any. Promptly after consulting with Engineer, Owner shall take such actions as are necessary to permit Owner to timely obtain required permits and provide Contractor the written notice required by Paragraph 4.06.E.
- E. Contractor shall not be required to resume Work in connection with such condition or in any affected area until after Owner has obtained any required permits related thereto and delivered written notice to Contractor: (i) specifying that such condition and any affected area is or has been rendered safe for the resumption of Work; or (ii) specifying any special conditions under which such Work may be resumed safely. If Owner and Contractor cannot agree as to entitlement to or on the amount or extent, if any, of any adjustment in Contract Price or Contract Times, or both, as a result of such Work stoppage or such special conditions under which Work is agreed to be resumed by Contractor, either party may make a Claim therefor as provided in Paragraph 10.05.
- F. If after receipt of such written notice Contractor does not agree to resume such Work based on a reasonable belief it is unsafe, or does not agree to resume such Work under such special conditions, then Owner may order the portion of the Work that is in the area affected by such condition to be deleted from the Work. If Owner and Contractor cannot agree as to entitlement to or on the amount or extent, if any, of an adjustment in Contract Price or Contract Times as a result of deleting such portion of the Work, then either party may make a Claim therefor as provided in Paragraph 10.05. Owner may have such deleted portion of the Work performed by Owner’s own forces or others in accordance with Article 7.
- G. To the fullest extent permitted by Laws and Regulations, Owner shall indemnify and hold harmless Contractor, Subcontractors, and Engineer, and the officers, directors, members, partners, employees,

agents, consultants, and subcontractors of each and any of them from and against all claims, costs, losses, and damages (including but not limited to all fees and charges of engineers, architects, attorneys, and other professionals and all court or arbitration or other dispute resolution costs) arising out of or relating to a Hazardous Environmental Condition, provided that such Hazardous Environmental Condition: (i) was not shown or indicated in the Drawings or Specifications or identified in the Contract Documents to be included within the scope of the Work, and (ii) was not created by Contractor or by anyone for whom Contractor is responsible. Nothing in this Paragraph 4.06.G shall obligate Owner to indemnify any individual or entity from and against the consequences of that individual's or entity's own negligence.

- H. To the fullest extent permitted by Laws and Regulations, Contractor shall indemnify and hold harmless Owner and Engineer, and the officers, directors, members, partners, employees, agents, consultants, and subcontractors of each and any of them from and against all claims, costs, losses, and damages (including but not limited to all fees and charges of engineers, architects, attorneys, and other professionals and all court or arbitration or other dispute resolution costs) arising out of or relating to a Hazardous Environmental Condition created by Contractor or by anyone for whom Contractor is responsible. Nothing in this Paragraph 4.06.H shall obligate Contractor to indemnify any individual or entity from and against the consequences of that individual's or entity's own negligence.
- I. The provisions of Paragraphs 4.02, 4.03, and 4.04 do not apply to a Hazardous Environmental Condition uncovered or revealed at the Site.

ARTICLE 5 – BONDS AND INSURANCE

5.01 Performance, Payment, and Other Bonds

- A. Contractor shall furnish performance and payment bonds, each in an amount at least equal to the Contract Price as security for the faithful performance and payment of all of Contractor's obligations under the Contract Documents. These bonds shall remain in effect until one year after the date when final payment becomes due or until completion of the correction period specified in Paragraph 13.07, whichever is later, except as provided otherwise by Laws or Regulations or by the Contract Documents. Contractor shall also furnish such other bonds as are required by the Contract Documents.
- B. All bonds shall be in the form prescribed by the Contract Documents except as provided otherwise by Laws or Regulations, and shall be executed by such sureties as are named in the list of "Companies Holding Certificates of Authority as Acceptable Sureties on Federal Bonds and as Acceptable Reinsuring Companies" as published in Circular 570 (amended) by the Financial Management Service, Surety Bond Branch, U.S. Department of the Treasury. All bonds signed by an agent or attorney-in-fact must be accompanied by a certified copy of that individual's authority to bind the surety. The evidence of authority shall show that it is effective on the date the agent or attorney-in-fact signed each bond.
- C. If the surety on any bond furnished by Contractor is declared bankrupt or becomes insolvent or its right to do business is terminated in any state where any part of the Project is located or it ceases to meet the requirements of Paragraph 5.01.B, Contractor shall promptly notify Owner and Engineer and shall, within 20 days after the event giving rise to such notification, provide another bond and surety, both of which shall comply with the requirements of Paragraphs 5.01.B and 5.02.

5.02 Licensed Sureties and Insurers

- A. All bonds and insurance required by the Contract Documents to be purchased and maintained by Owner or Contractor shall be obtained from surety or insurance companies that are duly licensed or authorized in the jurisdiction in which the Project is located to issue bonds or insurance policies for the limits and

coverages so required. Such surety and insurance companies shall also meet such additional requirements and qualifications as may be provided in the Supplementary Conditions.

5.03 *Certificates of Insurance*

- A. Contractor shall deliver to Owner, with copies to each additional insured and loss payee identified in the Supplementary Conditions, certificates of insurance (and other evidence of insurance requested by Owner or any other additional insured) which Contractor is required to purchase and maintain.
- B. Owner shall deliver to Contractor, with copies to each additional insured and loss payee identified in the Supplementary Conditions, certificates of insurance (and other evidence of insurance requested by Contractor or any other additional insured) which Owner is required to purchase and maintain.
- C. Failure of Owner to demand such certificates or other evidence of Contractor's full compliance with these insurance requirements or failure of Owner to identify a deficiency in compliance from the evidence provided shall not be construed as a waiver of Contractor's obligation to maintain such insurance.
- D. Owner does not represent that insurance coverage and limits established in this Contract necessarily will be adequate to protect Contractor.
- E. The insurance and insurance limits required herein shall not be deemed as a limitation on Contractor's liability under the indemnities granted to Owner in the Contract Documents.

5.04 *Contractor's Insurance*

- A. Contractor shall purchase and maintain such insurance as is appropriate for the Work being performed and as will provide protection from claims set forth below which may arise out of or result from Contractor's performance of the Work and Contractor's other obligations under the Contract Documents, whether it is to be performed by Contractor, any Subcontractor or Supplier, or by anyone directly or indirectly employed by any of them to perform any of the Work, or by anyone for whose acts any of them may be liable:
 - 1. claims under workers' compensation, disability benefits, and other similar employee benefit acts;
 - 2. claims for damages because of bodily injury, occupational sickness or disease, or death of Contractor's employees;
 - 3. claims for damages because of bodily injury, sickness or disease, or death of any person other than Contractor's employees;
 - 4. claims for damages insured by reasonably available personal injury liability coverage which are sustained:
 - a. by any person as a result of an offense directly or indirectly related to the employment of such person by Contractor, or
 - b. by any other person for any other reason;
 - 5. claims for damages, other than to the Work itself, because of injury to or destruction of tangible property wherever located, including loss of use resulting therefrom; and

6. claims for damages because of bodily injury or death of any person or property damage arising out of the ownership, maintenance or use of any motor vehicle.

B. The policies of insurance required by this Paragraph 5.04 shall:

1. with respect to insurance required by Paragraphs 5.04.A.3 through 5.04.A.6 inclusive, be written on an occurrence basis, include as additional insureds (subject to any customary exclusion regarding professional liability) Owner and Engineer, and any other individuals or entities identified in the Supplementary Conditions, all of whom shall be listed as additional insureds, and include coverage for the respective officers, directors, members, partners, employees, agents, consultants, and subcontractors of each and any of all such additional insureds, and the insurance afforded to these additional insureds shall provide primary coverage for all claims covered thereby;
2. include at least the specific coverages and be written for not less than the limits of liability provided in the Supplementary Conditions or required by Laws or Regulations, whichever is greater;
3. include contractual liability insurance covering Contractor's indemnity obligations under Paragraphs 6.11 and 6.20;
4. contain a provision or endorsement that the coverage afforded will not be canceled, materially changed or renewal refused until at least 30 days prior written notice has been given to Owner and Contractor and to each other additional insured identified in the Supplementary Conditions to whom a certificate of insurance has been issued (and the certificates of insurance furnished by the Contractor pursuant to Paragraph 5.03 will so provide);
5. remain in effect at least until final payment and at all times thereafter when Contractor may be correcting, removing, or replacing defective Work in accordance with Paragraph 13.07; and
6. include completed operations coverage:
 - a. Such insurance shall remain in effect for two years after final payment.
 - b. Contractor shall furnish Owner and each other additional insured identified in the Supplementary Conditions, to whom a certificate of insurance has been issued, evidence satisfactory to Owner and any such additional insured of continuation of such insurance at final payment and one year thereafter.

5.05 *Owner's Liability Insurance*

- A. In addition to the insurance required to be provided by Contractor under Paragraph 5.04, Owner, at Owner's option, may purchase and maintain at Owner's expense Owner's own liability insurance as will protect Owner against claims which may arise from operations under the Contract Documents.

5.06 *Property Insurance*

- A. Unless otherwise provided in the Supplementary Conditions, Owner shall purchase and maintain property insurance upon the Work at the Site in the amount of the full replacement cost thereof (subject to such deductible amounts as may be provided in the Supplementary Conditions or required by Laws and Regulations). This insurance shall:
 1. include the interests of Owner, Contractor, Subcontractors, and Engineer, and any other individuals or entities identified in the Supplementary Conditions, and the officers, directors, members, partners,

employees, agents, consultants, and subcontractors of each and any of them, each of whom is deemed to have an insurable interest and shall be listed as a loss payee;

2. be written on a Builder's Risk "all-risk" policy form that shall at least include insurance for physical loss or damage to the Work, temporary buildings, falsework, and materials and equipment in transit, and shall insure against at least the following perils or causes of loss: fire, lightning, extended coverage, theft, vandalism and malicious mischief, earthquake, collapse, debris removal, demolition occasioned by enforcement of Laws and Regulations, water damage (other than that caused by flood), and such other perils or causes of loss as may be specifically required by the Supplementary Conditions.
 3. include expenses incurred in the repair or replacement of any insured property (including but not limited to fees and charges of engineers and architects);
 4. cover materials and equipment stored at the Site or at another location that was agreed to in writing by Owner prior to being incorporated in the Work, provided that such materials and equipment have been included in an Application for Payment recommended by Engineer;
 5. allow for partial utilization of the Work by Owner;
 6. include testing and startup; and
 7. be maintained in effect until final payment is made unless otherwise agreed to in writing by Owner, Contractor, and Engineer with 30 days written notice to each other loss payee to whom a certificate of insurance has been issued.
- B. Owner shall purchase and maintain such equipment breakdown insurance or additional property insurance as may be required by the Supplementary Conditions or Laws and Regulations which will include the interests of Owner, Contractor, Subcontractors, and Engineer, and any other individuals or entities identified in the Supplementary Conditions, and the officers, directors, members, partners, employees, agents, consultants and subcontractors of each and any of them, each of whom is deemed to have an insurable interest and shall be listed as a loss payee.
- C. All the policies of insurance (and the certificates or other evidence thereof) required to be purchased and maintained in accordance with this Paragraph 5.06 will contain a provision or endorsement that the coverage afforded will not be canceled or materially changed or renewal refused until at least 30 days prior written notice has been given to Owner and Contractor and to each other loss payee to whom a certificate of insurance has been issued and will contain waiver provisions in accordance with Paragraph 5.07.
- D. Owner shall not be responsible for purchasing and maintaining any property insurance specified in this Paragraph 5.06 to protect the interests of Contractor, Subcontractors, or others in the Work to the extent of any deductible amounts that are identified in the Supplementary Conditions. The risk of loss within such identified deductible amount will be borne by Contractor, Subcontractors, or others suffering any such loss, and if any of them wishes property insurance coverage within the limits of such amounts, each may purchase and maintain it at the purchaser's own expense.
- E. If Contractor requests in writing that other special insurance be included in the property insurance policies provided under this Paragraph 5.06, Owner shall, if possible, include such insurance, and the cost thereof will be charged to Contractor by appropriate Change Order. Prior to commencement of the Work at the Site, Owner shall in writing advise Contractor whether or not such other insurance has been procured by Owner.

5.07 *Waiver of Rights*

- A. Owner and Contractor intend that all policies purchased in accordance with Paragraph 5.06 will protect Owner, Contractor, Subcontractors, and Engineer, and all other individuals or entities identified in the Supplementary Conditions as loss payees (and the officers, directors, members, partners, employees, agents, consultants, and subcontractors of each and any of them) in such policies and will provide primary coverage for all losses and damages caused by the perils or causes of loss covered thereby. All such policies shall contain provisions to the effect that in the event of payment of any loss or damage the insurers will have no rights of recovery against any of the insureds or loss payees thereunder. Owner and Contractor waive all rights against each other and their respective officers, directors, members, partners, employees, agents, consultants and subcontractors of each and any of them for all losses and damages caused by, arising out of or resulting from any of the perils or causes of loss covered by such policies and any other property insurance applicable to the Work; and, in addition, waive all such rights against Subcontractors and Engineer, and all other individuals or entities identified in the Supplementary Conditions as loss payees (and the officers, directors, members, partners, employees, agents, consultants, and subcontractors of each and any of them) under such policies for losses and damages so caused. None of the above waivers shall extend to the rights that any party making such waiver may have to the proceeds of insurance held by Owner as trustee or otherwise payable under any policy so issued.
- B. Owner waives all rights against Contractor, Subcontractors, and Engineer, and the officers, directors, members, partners, employees, agents, consultants and subcontractors of each and any of them for:
1. loss due to business interruption, loss of use, or other consequential loss extending beyond direct physical loss or damage to Owner's property or the Work caused by, arising out of, or resulting from fire or other perils whether or not insured by Owner; and
 2. loss or damage to the completed Project or part thereof caused by, arising out of, or resulting from fire or other insured peril or cause of loss covered by any property insurance maintained on the completed Project or part thereof by Owner during partial utilization pursuant to Paragraph 14.05, after Substantial Completion pursuant to Paragraph 14.04, or after final payment pursuant to Paragraph 14.07.
- C. Any insurance policy maintained by Owner covering any loss, damage or consequential loss referred to in Paragraph 5.07.B shall contain provisions to the effect that in the event of payment of any such loss, damage, or consequential loss, the insurers will have no rights of recovery against Contractor, Subcontractors, or Engineer, and the officers, directors, members, partners, employees, agents, consultants and subcontractors of each and any of them.

5.08 *Receipt and Application of Insurance Proceeds*

- A. Any insured loss under the policies of insurance required by Paragraph 5.06 will be adjusted with Owner and made payable to Owner as fiduciary for the loss payees, as their interests may appear, subject to the requirements of any applicable mortgage clause and of Paragraph 5.08.B. Owner shall deposit in a separate account any money so received and shall distribute it in accordance with such agreement as the parties in interest may reach. If no other special agreement is reached, the damaged Work shall be repaired or replaced, the moneys so received applied on account thereof, and the Work and the cost thereof covered by an appropriate Change Order.
- B. Owner as fiduciary shall have power to adjust and settle any loss with the insurers unless one of the parties in interest shall object in writing within 15 days after the occurrence of loss to Owner's exercise of this power. If such objection be made, Owner as fiduciary shall make settlement with the insurers in accordance with such agreement as the parties in interest may reach. If no such agreement among the

parties in interest is reached, Owner as fiduciary shall adjust and settle the loss with the insurers and, if required in writing by any party in interest, Owner as fiduciary shall give bond for the proper performance of such duties.

5.09 *Acceptance of Bonds and Insurance; Option to Replace*

- A. If either Owner or Contractor has any objection to the coverage afforded by or other provisions of the bonds or insurance required to be purchased and maintained by the other party in accordance with Article 5 on the basis of non-conformance with the Contract Documents, the objecting party shall so notify the other party in writing within 10 days after receipt of the certificates (or other evidence requested) required by Paragraph 2.01.B. Owner and Contractor shall each provide to the other such additional information in respect of insurance provided as the other may reasonably request. If either party does not purchase or maintain all of the bonds and insurance required of such party by the Contract Documents, such party shall notify the other party in writing of such failure to purchase prior to the start of the Work, or of such failure to maintain prior to any change in the required coverage. Without prejudice to any other right or remedy, the other party may elect to obtain equivalent bonds or insurance to protect such other party's interests at the expense of the party who was required to provide such coverage, and a Change Order shall be issued to adjust the Contract Price accordingly.

5.10 *Partial Utilization, Acknowledgment of Property Insurer*

- A. If Owner finds it necessary to occupy or use a portion or portions of the Work prior to Substantial Completion of all the Work as provided in Paragraph 14.05, no such use or occupancy shall commence before the insurers providing the property insurance pursuant to Paragraph 5.06 have acknowledged notice thereof and in writing effected any changes in coverage necessitated thereby. The insurers providing the property insurance shall consent by endorsement on the policy or policies, but the property insurance shall not be canceled or permitted to lapse on account of any such partial use or occupancy.

ARTICLE 6 – CONTRACTOR'S RESPONSIBILITIES

6.01 *Supervision and Superintendence*

- A. Contractor shall supervise, inspect, and direct the Work competently and efficiently, devoting such attention thereto and applying such skills and expertise as may be necessary to perform the Work in accordance with the Contract Documents. Contractor shall be solely responsible for the means, methods, techniques, sequences, and procedures of construction. Contractor shall not be responsible for the negligence of Owner or Engineer in the design or specification of a specific means, method, technique, sequence, or procedure of construction which is shown or indicated in and expressly required by the Contract Documents.
- B. At all times during the progress of the Work, Contractor shall assign a competent resident superintendent who shall not be replaced without written notice to Owner and Engineer except under extraordinary circumstances.

6.02 *Labor; Working Hours*

- A. Contractor shall provide competent, suitably qualified personnel to survey and lay out the Work and perform construction as required by the Contract Documents. Contractor shall at all times maintain good discipline and order at the Site.
- B. Except as otherwise required for the safety or protection of persons or the Work or property at the Site or adjacent thereto, and except as otherwise stated in the Contract Documents, all Work at the Site shall be

performed during regular working hours. Contractor will not permit the performance of Work on a Saturday, Sunday, or any legal holiday without Owner's written consent (which will not be unreasonably withheld) given after prior written notice to Engineer.

6.03 *Services, Materials, and Equipment*

- A. Unless otherwise specified in the Contract Documents, Contractor shall provide and assume full responsibility for all services, materials, equipment, labor, transportation, construction equipment and machinery, tools, appliances, fuel, power, light, heat, telephone, water, sanitary facilities, temporary facilities, and all other facilities and incidentals necessary for the performance, testing, start-up, and completion of the Work.
- B. All materials and equipment incorporated into the Work shall be as specified or, if not specified, shall be of good quality and new, except as otherwise provided in the Contract Documents. All special warranties and guarantees required by the Specifications shall expressly run to the benefit of Owner. If required by Engineer, Contractor shall furnish satisfactory evidence (including reports of required tests) as to the source, kind, and quality of materials and equipment.
- C. All materials and equipment shall be stored, applied, installed, connected, erected, protected, used, cleaned, and conditioned in accordance with instructions of the applicable Supplier, except as otherwise may be provided in the Contract Documents.

6.04 *Progress Schedule*

- A. Contractor shall adhere to the Progress Schedule established in accordance with Paragraph 2.07 as it may be adjusted from time to time as provided below.
 - 1. Contractor shall submit to Engineer for acceptance (to the extent indicated in Paragraph 2.07) proposed adjustments in the Progress Schedule that will not result in changing the Contract Times. Such adjustments will comply with any provisions of the General Requirements applicable thereto.
 - 2. Proposed adjustments in the Progress Schedule that will change the Contract Times shall be submitted in accordance with the requirements of Article 12. Adjustments in Contract Times may only be made by a Change Order.

6.05 *Substitutes and "Or-Equals"*

- A. Whenever an item of material or equipment is specified or described in the Contract Documents by using the name of a proprietary item or the name of a particular Supplier, the specification or description is intended to establish the type, function, appearance, and quality required. Unless the specification or description contains or is followed by words reading that no like, equivalent, or "or-equal" item or no substitution is permitted, other items of material or equipment or material or equipment of other Suppliers may be submitted to Engineer for review under the circumstances described below.
 - 1. *"Or-Equal" Items:* If in Engineer's sole discretion an item of material or equipment proposed by Contractor is functionally equal to that named and sufficiently similar so that no change in related Work will be required, it may be considered by Engineer as an "or-equal" item, in which case review and approval of the proposed item may, in Engineer's sole discretion, be accomplished without compliance with some or all of the requirements for approval of proposed substitute items. For the purposes of this Paragraph 6.05.A.1, a proposed item of material or equipment will be considered functionally equal to an item so named if:

- a. in the exercise of reasonable judgment Engineer determines that:
 - 1) it is at least equal in materials of construction, quality, durability, appearance, strength, and design characteristics;
 - 2) it will reliably perform at least equally well the function and achieve the results imposed by the design concept of the completed Project as a functioning whole; and
 - 3) it has a proven record of performance and availability of responsive service.
- b. Contractor certifies that, if approved and incorporated into the Work:
 - 1) there will be no increase in cost to the Owner or increase in Contract Times; and
 - 2) it will conform substantially to the detailed requirements of the item named in the Contract Documents.

2. *Substitute Items:*

- a. If in Engineer's sole discretion an item of material or equipment proposed by Contractor does not qualify as an "or-equal" item under Paragraph 6.05.A.1, it will be considered a proposed substitute item.
- b. Contractor shall submit sufficient information as provided below to allow Engineer to determine if the item of material or equipment proposed is essentially equivalent to that named and an acceptable substitute therefor. Requests for review of proposed substitute items of material or equipment will not be accepted by Engineer from anyone other than Contractor.
- c. The requirements for review by Engineer will be as set forth in Paragraph 6.05.A.2.d, as supplemented by the General Requirements, and as Engineer may decide is appropriate under the circumstances.
- d. Contractor shall make written application to Engineer for review of a proposed substitute item of material or equipment that Contractor seeks to furnish or use. The application:
 - 1) shall certify that the proposed substitute item will:
 - a) perform adequately the functions and achieve the results called for by the general design,
 - b) be similar in substance to that specified, and
 - c) be suited to the same use as that specified;
 - 2) will state:
 - a) the extent, if any, to which the use of the proposed substitute item will prejudice Contractor's achievement of Substantial Completion on time,
 - b) whether use of the proposed substitute item in the Work will require a change in any of the Contract Documents (or in the provisions of any other direct contract with Owner for other work on the Project) to adapt the design to the proposed substitute item, and

- c) whether incorporation or use of the proposed substitute item in connection with the Work is subject to payment of any license fee or royalty;
- 3) will identify:
 - a) all variations of the proposed substitute item from that specified, and
 - b) available engineering, sales, maintenance, repair, and replacement services; and
- 4) shall contain an itemized estimate of all costs or credits that will result directly or indirectly from use of such substitute item, including costs of redesign and claims of other contractors affected by any resulting change.

- B. *Substitute Construction Methods or Procedures:* If a specific means, method, technique, sequence, or procedure of construction is expressly required by the Contract Documents, Contractor may furnish or utilize a substitute means, method, technique, sequence, or procedure of construction approved by Engineer. Contractor shall submit sufficient information to allow Engineer, in Engineer's sole discretion, to determine that the substitute proposed is equivalent to that expressly called for by the Contract Documents. The requirements for review by Engineer will be similar to those provided in Paragraph 6.05.A.2.
- C. *Engineer's Evaluation:* Engineer will be allowed a reasonable time within which to evaluate each proposal or submittal made pursuant to Paragraphs 6.05.A and 6.05.B. Engineer may require Contractor to furnish additional data about the proposed substitute item. Engineer will be the sole judge of acceptability. No "or equal" or substitute will be ordered, installed or utilized until Engineer's review is complete, which will be evidenced by a Change Order in the case of a substitute and an approved Shop Drawing for an "or equal." Engineer will advise Contractor in writing of any negative determination.
- D. *Special Guarantee:* Owner may require Contractor to furnish at Contractor's expense a special performance guarantee or other surety with respect to any substitute.
- E. *Engineer's Cost Reimbursement:* Engineer will record Engineer's costs in evaluating a substitute proposed or submitted by Contractor pursuant to Paragraphs 6.05.A.2 and 6.05.B. Whether or not Engineer approves a substitute so proposed or submitted by Contractor, Contractor shall reimburse Owner for the reasonable charges of Engineer for evaluating each such proposed substitute. Contractor shall also reimburse Owner for the reasonable charges of Engineer for making changes in the Contract Documents (or in the provisions of any other direct contract with Owner) resulting from the acceptance of each proposed substitute.
- F. *Contractor's Expense:* Contractor shall provide all data in support of any proposed substitute or "or-equal" at Contractor's expense.

6.06 *Concerning Subcontractors, Suppliers, and Others*

- A. Contractor shall not employ any Subcontractor, Supplier, or other individual or entity (including those acceptable to Owner as indicated in Paragraph 6.06.B), whether initially or as a replacement, against whom Owner may have reasonable objection. Contractor shall not be required to employ any Subcontractor, Supplier, or other individual or entity to furnish or perform any of the Work against whom Contractor has reasonable objection.
- B. If the Supplementary Conditions require the identity of certain Subcontractors, Suppliers, or other individuals or entities to be submitted to Owner in advance for acceptance by Owner by a specified date

prior to the Effective Date of the Agreement, and if Contractor has submitted a list thereof in accordance with the Supplementary Conditions, Owner's acceptance (either in writing or by failing to make written objection thereto by the date indicated for acceptance or objection in the Bidding Documents or the Contract Documents) of any such Subcontractor, Supplier, or other individual or entity so identified may be revoked on the basis of reasonable objection after due investigation. Contractor shall submit an acceptable replacement for the rejected Subcontractor, Supplier, or other individual or entity, and the Contract Price will be adjusted by the difference in the cost occasioned by such replacement, and an appropriate Change Order will be issued. No acceptance by Owner of any such Subcontractor, Supplier, or other individual or entity, whether initially or as a replacement, shall constitute a waiver of any right of Owner or Engineer to reject defective Work.

- C. Contractor shall be fully responsible to Owner and Engineer for all acts and omissions of the Subcontractors, Suppliers, and other individuals or entities performing or furnishing any of the Work just as Contractor is responsible for Contractor's own acts and omissions. Nothing in the Contract Documents:
 - 1. shall create for the benefit of any such Subcontractor, Supplier, or other individual or entity any contractual relationship between Owner or Engineer and any such Subcontractor, Supplier or other individual or entity; nor
 - 2. shall create any obligation on the part of Owner or Engineer to pay or to see to the payment of any moneys due any such Subcontractor, Supplier, or other individual or entity except as may otherwise be required by Laws and Regulations.
- D. Contractor shall be solely responsible for scheduling and coordinating the Work of Subcontractors, Suppliers, and other individuals or entities performing or furnishing any of the Work under a direct or indirect contract with Contractor.
- E. Contractor shall require all Subcontractors, Suppliers, and such other individuals or entities performing or furnishing any of the Work to communicate with Engineer through Contractor.
- F. The divisions and sections of the Specifications and the identifications of any Drawings shall not control Contractor in dividing the Work among Subcontractors or Suppliers or delineating the Work to be performed by any specific trade.
- G. All Work performed for Contractor by a Subcontractor or Supplier will be pursuant to an appropriate agreement between Contractor and the Subcontractor or Supplier which specifically binds the Subcontractor or Supplier to the applicable terms and conditions of the Contract Documents for the benefit of Owner and Engineer. Whenever any such agreement is with a Subcontractor or Supplier who is listed as a loss payee on the property insurance provided in Paragraph 5.06, the agreement between the Contractor and the Subcontractor or Supplier will contain provisions whereby the Subcontractor or Supplier waives all rights against Owner, Contractor, Engineer, and all other individuals or entities identified in the Supplementary Conditions to be listed as insureds or loss payees (and the officers, directors, members, partners, employees, agents, consultants, and subcontractors of each and any of them) for all losses and damages caused by, arising out of, relating to, or resulting from any of the perils or causes of loss covered by such policies and any other property insurance applicable to the Work. If the insurers on any such policies require separate waiver forms to be signed by any Subcontractor or Supplier, Contractor will obtain the same.

6.07 *Patent Fees and Royalties*

- A. Contractor shall pay all license fees and royalties and assume all costs incident to the use in the performance of the Work or the incorporation in the Work of any invention, design, process, product, or device which is the subject of patent rights or copyrights held by others. If a particular invention, design, process, product, or device is specified in the Contract Documents for use in the performance of the Work and if, to the actual knowledge of Owner or Engineer, its use is subject to patent rights or copyrights calling for the payment of any license fee or royalty to others, the existence of such rights shall be disclosed by Owner in the Contract Documents.
- B. To the fullest extent permitted by Laws and Regulations, Owner shall indemnify and hold harmless Contractor, and its officers, directors, members, partners, employees, agents, consultants, and subcontractors from and against all claims, costs, losses, and damages (including but not limited to all fees and charges of engineers, architects, attorneys, and other professionals, and all court or arbitration or other dispute resolution costs) arising out of or relating to any infringement of patent rights or copyrights incident to the use in the performance of the Work or resulting from the incorporation in the Work of any invention, design, process, product, or device specified in the Contract Documents, but not identified as being subject to payment of any license fee or royalty to others required by patent rights or copyrights.
- C. To the fullest extent permitted by Laws and Regulations, Contractor shall indemnify and hold harmless Owner and Engineer, and the officers, directors, members, partners, employees, agents, consultants and subcontractors of each and any of them from and against all claims, costs, losses, and damages (including but not limited to all fees and charges of engineers, architects, attorneys, and other professionals and all court or arbitration or other dispute resolution costs) arising out of or relating to any infringement of patent rights or copyrights incident to the use in the performance of the Work or resulting from the incorporation in the Work of any invention, design, process, product, or device not specified in the Contract Documents.

6.08 *Permits*

- A. Unless otherwise provided in the Supplementary Conditions, Contractor shall obtain and pay for all construction permits and licenses. Owner shall assist Contractor, when necessary, in obtaining such permits and licenses. Contractor shall pay all governmental charges and inspection fees necessary for the prosecution of the Work which are applicable at the time of opening of Bids, or, if there are no Bids, on the Effective Date of the Agreement. Owner shall pay all charges of utility owners for connections for providing permanent service to the Work.

6.09 *Laws and Regulations*

- A. Contractor shall give all notices required by and shall comply with all Laws and Regulations applicable to the performance of the Work. Except where otherwise expressly required by applicable Laws and Regulations, neither Owner nor Engineer shall be responsible for monitoring Contractor's compliance with any Laws or Regulations.
- B. If Contractor performs any Work knowing or having reason to know that it is contrary to Laws or Regulations, Contractor shall bear all claims, costs, losses, and damages (including but not limited to all fees and charges of engineers, architects, attorneys, and other professionals and all court or arbitration or other dispute resolution costs) arising out of or relating to such Work. However, it shall not be Contractor's responsibility to make certain that the Specifications and Drawings are in accordance with Laws and Regulations, but this shall not relieve Contractor of Contractor's obligations under Paragraph 3.03.

- C. Changes in Laws or Regulations not known at the time of opening of Bids (or, on the Effective Date of the Agreement if there were no Bids) having an effect on the cost or time of performance of the Work shall be the subject of an adjustment in Contract Price or Contract Times. If Owner and Contractor are unable to agree on entitlement to or on the amount or extent, if any, of any such adjustment, a Claim may be made therefor as provided in Paragraph 10.05.

6.10 *Taxes*

- A. Contractor shall pay all sales, consumer, use, and other similar taxes required to be paid by Contractor in accordance with the Laws and Regulations of the place of the Project which are applicable during the performance of the Work.

6.11 *Use of Site and Other Areas*

A. *Limitation on Use of Site and Other Areas:*

1. Contractor shall confine construction equipment, the storage of materials and equipment, and the operations of workers to the Site and other areas permitted by Laws and Regulations, and shall not unreasonably encumber the Site and other areas with construction equipment or other materials or equipment. Contractor shall assume full responsibility for any damage to any such land or area, or to the owner or occupant thereof, or of any adjacent land or areas resulting from the performance of the Work.
2. Should any claim be made by any such owner or occupant because of the performance of the Work, Contractor shall promptly settle with such other party by negotiation or otherwise resolve the claim by arbitration or other dispute resolution proceeding or at law.
3. To the fullest extent permitted by Laws and Regulations, Contractor shall indemnify and hold harmless Owner and Engineer, and the officers, directors, members, partners, employees, agents, consultants and subcontractors of each and any of them from and against all claims, costs, losses, and damages (including but not limited to all fees and charges of engineers, architects, attorneys, and other professionals and all court or arbitration or other dispute resolution costs) arising out of or relating to any claim or action, legal or equitable, brought by any such owner or occupant against Owner, Engineer, or any other party indemnified hereunder to the extent caused by or based upon Contractor's performance of the Work.

- B. *Removal of Debris During Performance of the Work:* During the progress of the Work Contractor shall keep the Site and other areas free from accumulations of waste materials, rubbish, and other debris. Removal and disposal of such waste materials, rubbish, and other debris shall conform to applicable Laws and Regulations.

- C. *Cleaning:* Prior to Substantial Completion of the Work Contractor shall clean the Site and the Work and make it ready for utilization by Owner. At the completion of the Work Contractor shall remove from the Site all tools, appliances, construction equipment and machinery, and surplus materials and shall restore to original condition all property not designated for alteration by the Contract Documents.

- D. *Loading Structures:* Contractor shall not load nor permit any part of any structure to be loaded in any manner that will endanger the structure, nor shall Contractor subject any part of the Work or adjacent property to stresses or pressures that will endanger it.

6.12 *Record Documents*

- A. Contractor shall maintain in a safe place at the Site one record copy of all Drawings, Specifications, Addenda, Change Orders, Work Change Directives, Field Orders, and written interpretations and clarifications in good order and annotated to show changes made during construction. These record documents together with all approved Samples and a counterpart of all approved Shop Drawings will be available to Engineer for reference. Upon completion of the Work, these record documents, Samples, and Shop Drawings will be delivered to Engineer for Owner.

6.13 *Safety and Protection*

- A. Contractor shall be solely responsible for initiating, maintaining and supervising all safety precautions and programs in connection with the Work. Such responsibility does not relieve Subcontractors of their responsibility for the safety of persons or property in the performance of their work, nor for compliance with applicable safety Laws and Regulations. Contractor shall take all necessary precautions for the safety of, and shall provide the necessary protection to prevent damage, injury or loss to:
 - 1. all persons on the Site or who may be affected by the Work;
 - 2. all the Work and materials and equipment to be incorporated therein, whether in storage on or off the Site; and
 - 3. other property at the Site or adjacent thereto, including trees, shrubs, lawns, walks, pavements, roadways, structures, utilities, and Underground Facilities not designated for removal, relocation, or replacement in the course of construction.
- B. Contractor shall comply with all applicable Laws and Regulations relating to the safety of persons or property, or to the protection of persons or property from damage, injury, or loss; and shall erect and maintain all necessary safeguards for such safety and protection. Contractor shall notify owners of adjacent property and of Underground Facilities and other utility owners when prosecution of the Work may affect them, and shall cooperate with them in the protection, removal, relocation, and replacement of their property.
- C. Contractor shall comply with the applicable requirements of Owner's safety programs, if any. The Supplementary Conditions identify any Owner's safety programs that are applicable to the Work.
- D. Contractor shall inform Owner and Engineer of the specific requirements of Contractor's safety program with which Owner's and Engineer's employees and representatives must comply while at the Site.
- E. All damage, injury, or loss to any property referred to in Paragraph 6.13.A.2 or 6.13.A.3 caused, directly or indirectly, in whole or in part, by Contractor, any Subcontractor, Supplier, or any other individual or entity directly or indirectly employed by any of them to perform any of the Work, or anyone for whose acts any of them may be liable, shall be remedied by Contractor (except damage or loss attributable to the fault of Drawings or Specifications or to the acts or omissions of Owner or Engineer or anyone employed by any of them, or anyone for whose acts any of them may be liable, and not attributable, directly or indirectly, in whole or in part, to the fault or negligence of Contractor or any Subcontractor, Supplier, or other individual or entity directly or indirectly employed by any of them).
- F. Contractor's duties and responsibilities for safety and for protection of the Work shall continue until such time as all the Work is completed and Engineer has issued a notice to Owner and Contractor in accordance with Paragraph 14.07.B that the Work is acceptable (except as otherwise expressly provided in connection with Substantial Completion).

6.14 *Safety Representative*

- A. Contractor shall designate a qualified and experienced safety representative at the Site whose duties and responsibilities shall be the prevention of accidents and the maintaining and supervising of safety precautions and programs.

6.15 *Hazard Communication Programs*

- A. Contractor shall be responsible for coordinating any exchange of material safety data sheets or other hazard communication information required to be made available to or exchanged between or among employers at the Site in accordance with Laws or Regulations.

6.16 *Emergencies*

- A. In emergencies affecting the safety or protection of persons or the Work or property at the Site or adjacent thereto, Contractor is obligated to act to prevent threatened damage, injury, or loss. Contractor shall give Engineer prompt written notice if Contractor believes that any significant changes in the Work or variations from the Contract Documents have been caused thereby or are required as a result thereof. If Engineer determines that a change in the Contract Documents is required because of the action taken by Contractor in response to such an emergency, a Work Change Directive or Change Order will be issued.

6.17 *Shop Drawings and Samples*

- A. Contractor shall submit Shop Drawings and Samples to Engineer for review and approval in accordance with the accepted Schedule of Submittals (as required by Paragraph 2.07). Each submittal will be identified as Engineer may require.

- 1. *Shop Drawings:*

- a. Submit number of copies specified in the General Requirements.
- b. Data shown on the Shop Drawings will be complete with respect to quantities, dimensions, specified performance and design criteria, materials, and similar data to show Engineer the services, materials, and equipment Contractor proposes to provide and to enable Engineer to review the information for the limited purposes required by Paragraph 6.17.D.

- 2. *Samples:*

- a. Submit number of Samples specified in the Specifications.
- b. Clearly identify each Sample as to material, Supplier, pertinent data such as catalog numbers, the use for which intended and other data as Engineer may require to enable Engineer to review the submittal for the limited purposes required by Paragraph 6.17.D.

- B. Where a Shop Drawing or Sample is required by the Contract Documents or the Schedule of Submittals, any related Work performed prior to Engineer's review and approval of the pertinent submittal will be at the sole expense and responsibility of Contractor.

C. *Submittal Procedures:*

1. Before submitting each Shop Drawing or Sample, Contractor shall have:
 - a. reviewed and coordinated each Shop Drawing or Sample with other Shop Drawings and Samples and with the requirements of the Work and the Contract Documents;
 - b. determined and verified all field measurements, quantities, dimensions, specified performance and design criteria, installation requirements, materials, catalog numbers, and similar information with respect thereto;
 - c. determined and verified the suitability of all materials offered with respect to the indicated application, fabrication, shipping, handling, storage, assembly, and installation pertaining to the performance of the Work; and
 - d. determined and verified all information relative to Contractor's responsibilities for means, methods, techniques, sequences, and procedures of construction, and safety precautions and programs incident thereto.
2. Each submittal shall bear a stamp or specific written certification that Contractor has satisfied Contractor's obligations under the Contract Documents with respect to Contractor's review and approval of that submittal.
3. With each submittal, Contractor shall give Engineer specific written notice of any variations that the Shop Drawing or Sample may have from the requirements of the Contract Documents. This notice shall be both a written communication separate from the Shop Drawings or Sample submittal; and, in addition, by a specific notation made on each Shop Drawing or Sample submitted to Engineer for review and approval of each such variation.

D. *Engineer's Review:*

1. Engineer will provide timely review of Shop Drawings and Samples in accordance with the Schedule of Submittals acceptable to Engineer. Engineer's review and approval will be only to determine if the items covered by the submittals will, after installation or incorporation in the Work, conform to the information given in the Contract Documents and be compatible with the design concept of the completed Project as a functioning whole as indicated by the Contract Documents.
2. Engineer's review and approval will not extend to means, methods, techniques, sequences, or procedures of construction (except where a particular means, method, technique, sequence, or procedure of construction is specifically and expressly called for by the Contract Documents) or to safety precautions or programs incident thereto. The review and approval of a separate item as such will not indicate approval of the assembly in which the item functions.
3. Engineer's review and approval shall not relieve Contractor from responsibility for any variation from the requirements of the Contract Documents unless Contractor has complied with the requirements of Paragraph 6.17.C.3 and Engineer has given written approval of each such variation by specific written notation thereof incorporated in or accompanying the Shop Drawing or Sample. Engineer's review and approval shall not relieve Contractor from responsibility for complying with the requirements of Paragraph 6.17.C.1.

E. *Resubmittal Procedures:*

1. Contractor shall make corrections required by Engineer and shall return the required number of corrected copies of Shop Drawings and submit, as required, new Samples for review and approval. Contractor shall direct specific attention in writing to revisions other than the corrections called for by Engineer on previous submittals.

6.18 *Continuing the Work*

- A. Contractor shall carry on the Work and adhere to the Progress Schedule during all disputes or disagreements with Owner. No Work shall be delayed or postponed pending resolution of any disputes or disagreements, except as permitted by Paragraph 15.04 or as Owner and Contractor may otherwise agree in writing.

6.19 *Contractor's General Warranty and Guarantee*

- A. Contractor warrants and guarantees to Owner that all Work will be in accordance with the Contract Documents and will not be defective. Engineer and its officers, directors, members, partners, employees, agents, consultants, and subcontractors shall be entitled to rely on representation of Contractor's warranty and guarantee.
- B. Contractor's warranty and guarantee hereunder excludes defects or damage caused by:
 1. abuse, modification, or improper maintenance or operation by persons other than Contractor, Subcontractors, Suppliers, or any other individual or entity for whom Contractor is responsible; or
 2. normal wear and tear under normal usage.
- C. Contractor's obligation to perform and complete the Work in accordance with the Contract Documents shall be absolute. None of the following will constitute an acceptance of Work that is not in accordance with the Contract Documents or a release of Contractor's obligation to perform the Work in accordance with the Contract Documents:
 1. observations by Engineer;
 2. recommendation by Engineer or payment by Owner of any progress or final payment;
 3. the issuance of a certificate of Substantial Completion by Engineer or any payment related thereto by Owner;
 4. use or occupancy of the Work or any part thereof by Owner;
 5. any review and approval of a Shop Drawing or Sample submittal or the issuance of a notice of acceptability by Engineer;
 6. any inspection, test, or approval by others; or
 7. any correction of defective Work by Owner.

6.20 *Indemnification*

- A. To the fullest extent permitted by Laws and Regulations, Contractor shall indemnify and hold harmless Owner and Engineer, and the officers, directors, members, partners, employees, agents, consultants and subcontractors of each and any of them from and against all claims, costs, losses, and damages (including

but not limited to all fees and charges of engineers, architects, attorneys, and other professionals and all court or arbitration or other dispute resolution costs) arising out of or relating to the performance of the Work, provided that any such claim, cost, loss, or damage is attributable to bodily injury, sickness, disease, or death, or to injury to or destruction of tangible property (other than the Work itself), including the loss of use resulting therefrom but only to the extent caused by any negligent act or omission of Contractor, any Subcontractor, any Supplier, or any individual or entity directly or indirectly employed by any of them to perform any of the Work or anyone for whose acts any of them may be liable .

- B. In any and all claims against Owner or Engineer or any of their officers, directors, members, partners, employees, agents, consultants, or subcontractors by any employee (or the survivor or personal representative of such employee) of Contractor, any Subcontractor, any Supplier, or any individual or entity directly or indirectly employed by any of them to perform any of the Work, or anyone for whose acts any of them may be liable, the indemnification obligation under Paragraph 6.20.A shall not be limited in any way by any limitation on the amount or type of damages, compensation, or benefits payable by or for Contractor or any such Subcontractor, Supplier, or other individual or entity under workers' compensation acts, disability benefit acts, or other employee benefit acts.
- C. The indemnification obligations of Contractor under Paragraph 6.20.A shall not extend to the liability of Engineer and Engineer's officers, directors, members, partners, employees, agents, consultants and subcontractors arising out of:
 - 1. the preparation or approval of, or the failure to prepare or approve maps, Drawings, opinions, reports, surveys, Change Orders, designs, or Specifications; or
 - 2. giving directions or instructions, or failing to give them, if that is the primary cause of the injury or damage.

6.21 *Delegation of Professional Design Services*

- A. Contractor will not be required to provide professional design services unless such services are specifically required by the Contract Documents for a portion of the Work or unless such services are required to carry out Contractor's responsibilities for construction means, methods, techniques, sequences and procedures. Contractor shall not be required to provide professional services in violation of applicable law.
- B. If professional design services or certifications by a design professional related to systems, materials or equipment are specifically required of Contractor by the Contract Documents, Owner and Engineer will specify all performance and design criteria that such services must satisfy. Contractor shall cause such services or certifications to be provided by a properly licensed professional, whose signature and seal shall appear on all drawings, calculations, specifications, certifications, Shop Drawings and other submittals prepared by such professional. Shop Drawings and other submittals related to the Work designed or certified by such professional, if prepared by others, shall bear such professional's written approval when submitted to Engineer.
- C. Owner and Engineer shall be entitled to rely upon the adequacy, accuracy and completeness of the services, certifications or approvals performed by such design professionals, provided Owner and Engineer have specified to Contractor all performance and design criteria that such services must satisfy.
- D. Pursuant to this Paragraph 6.21, Engineer's review and approval of design calculations and design drawings will be only for the limited purpose of checking for conformance with performance and design criteria given and the design concept expressed in the Contract Documents. Engineer's review and

approval of Shop Drawings and other submittals (except design calculations and design drawings) will be only for the purpose stated in Paragraph 6.17.D.1.

- E. Contractor shall not be responsible for the adequacy of the performance or design criteria required by the Contract Documents.

ARTICLE 7 – OTHER WORK AT THE SITE

7.01 Related Work at Site

- A. Owner may perform other work related to the Project at the Site with Owner's employees, or through other direct contracts therefor, or have other work performed by utility owners. If such other work is not noted in the Contract Documents, then:
 - 1. written notice thereof will be given to Contractor prior to starting any such other work; and
 - 2. if Owner and Contractor are unable to agree on entitlement to or on the amount or extent, if any, of any adjustment in the Contract Price or Contract Times that should be allowed as a result of such other work, a Claim may be made therefor as provided in Paragraph 10.05.
- B. Contractor shall afford each other contractor who is a party to such a direct contract, each utility owner, and Owner, if Owner is performing other work with Owner's employees, proper and safe access to the Site, provide a reasonable opportunity for the introduction and storage of materials and equipment and the execution of such other work, and properly coordinate the Work with theirs. Contractor shall do all cutting, fitting, and patching of the Work that may be required to properly connect or otherwise make its several parts come together and properly integrate with such other work. Contractor shall not endanger any work of others by cutting, excavating, or otherwise altering such work; provided, however, that Contractor may cut or alter others' work with the written consent of Engineer and the others whose work will be affected. The duties and responsibilities of Contractor under this Paragraph are for the benefit of such utility owners and other contractors to the extent that there are comparable provisions for the benefit of Contractor in said direct contracts between Owner and such utility owners and other contractors.
- C. If the proper execution or results of any part of Contractor's Work depends upon work performed by others under this Article 7, Contractor shall inspect such other work and promptly report to Engineer in writing any delays, defects, or deficiencies in such other work that render it unavailable or unsuitable for the proper execution and results of Contractor's Work. Contractor's failure to so report will constitute an acceptance of such other work as fit and proper for integration with Contractor's Work except for latent defects and deficiencies in such other work.

7.02 Coordination

- A. If Owner intends to contract with others for the performance of other work on the Project at the Site, the following will be set forth in Supplementary Conditions:
 - 1. the individual or entity who will have authority and responsibility for coordination of the activities among the various contractors will be identified;
 - 2. the specific matters to be covered by such authority and responsibility will be itemized; and
 - 3. the extent of such authority and responsibilities will be provided.

- B. Unless otherwise provided in the Supplementary Conditions, Owner shall have sole authority and responsibility for such coordination.

7.03 *Legal Relationships*

- A. Paragraphs 7.01.A and 7.02 are not applicable for utilities not under the control of Owner.
- B. Each other direct contract of Owner under Paragraph 7.01.A shall provide that the other contractor is liable to Owner and Contractor for the reasonable direct delay and disruption costs incurred by Contractor as a result of the other contractor's wrongful actions or inactions.
- C. Contractor shall be liable to Owner and any other contractor under direct contract to Owner for the reasonable direct delay and disruption costs incurred by such other contractor as a result of Contractor's wrongful action or inactions.

ARTICLE 8 – OWNER'S RESPONSIBILITIES

8.01 *Communications to Contractor*

- A. Except as otherwise provided in these General Conditions, Owner shall issue all communications to Contractor through Engineer.

8.02 *Replacement of Engineer*

- A. In case of termination of the employment of Engineer, Owner shall appoint an engineer to whom Contractor makes no reasonable objection, whose status under the Contract Documents shall be that of the former Engineer.

8.03 *Furnish Data*

- A. Owner shall promptly furnish the data required of Owner under the Contract Documents.

8.04 *Pay When Due*

- A. Owner shall make payments to Contractor when they are due as provided in Paragraphs 14.02.C and 14.07.C.

8.05 *Lands and Easements; Reports and Tests*

- A. Owner's duties with respect to providing lands and easements and providing engineering surveys to establish reference points are set forth in Paragraphs 4.01 and 4.05. Paragraph 4.02 refers to Owner's identifying and making available to Contractor copies of reports of explorations and tests of subsurface conditions and drawings of physical conditions relating to existing surface or subsurface structures at the Site.

8.06 *Insurance*

- A. Owner's responsibilities, if any, with respect to purchasing and maintaining liability and property insurance are set forth in Article 5.

8.07 *Change Orders*

A. Owner is obligated to execute Change Orders as indicated in Paragraph 10.03.

8.08 *Inspections, Tests, and Approvals*

A. Owner's responsibility with respect to certain inspections, tests, and approvals is set forth in Paragraph 13.03.B.

8.09 *Limitations on Owner's Responsibilities*

A. The Owner shall not supervise, direct, or have control or authority over, nor be responsible for, Contractor's means, methods, techniques, sequences, or procedures of construction, or the safety precautions and programs incident thereto, or for any failure of Contractor to comply with Laws and Regulations applicable to the performance of the Work. Owner will not be responsible for Contractor's failure to perform the Work in accordance with the Contract Documents.

8.10 *Undisclosed Hazardous Environmental Condition*

A. Owner's responsibility in respect to an undisclosed Hazardous Environmental Condition is set forth in Paragraph 4.06.

8.11 *Evidence of Financial Arrangements*

A. Upon request of Contractor, Owner shall furnish Contractor reasonable evidence that financial arrangements have been made to satisfy Owner's obligations under the Contract Documents.

8.12 *Compliance with Safety Program*

A. While at the Site, Owner's employees and representatives shall comply with the specific applicable requirements of Contractor's safety programs of which Owner has been informed pursuant to Paragraph 6.13.D.

ARTICLE 9 – ENGINEER'S STATUS DURING CONSTRUCTION

9.01 *Owner's Representative*

A. Engineer will be Owner's representative during the construction period. The duties and responsibilities and the limitations of authority of Engineer as Owner's representative during construction are set forth in the Contract Documents.

9.02 *Visits to Site*

A. Engineer will make visits to the Site at intervals appropriate to the various stages of construction as Engineer deems necessary in order to observe as an experienced and qualified design professional the progress that has been made and the quality of the various aspects of Contractor's executed Work. Based on information obtained during such visits and observations, Engineer, for the benefit of Owner, will determine, in general, if the Work is proceeding in accordance with the Contract Documents. Engineer will not be required to make exhaustive or continuous inspections on the Site to check the quality or quantity of the Work. Engineer's efforts will be directed toward providing for Owner a greater degree of confidence that the completed Work will conform generally to the Contract Documents. On the basis of

such visits and observations, Engineer will keep Owner informed of the progress of the Work and will endeavor to guard Owner against defective Work.

- B. Engineer's visits and observations are subject to all the limitations on Engineer's authority and responsibility set forth in Paragraph 9.09. Particularly, but without limitation, during or as a result of Engineer's visits or observations of Contractor's Work, Engineer will not supervise, direct, control, or have authority over or be responsible for Contractor's means, methods, techniques, sequences, or procedures of construction, or the safety precautions and programs incident thereto, or for any failure of Contractor to comply with Laws and Regulations applicable to the performance of the Work.

9.03 *Project Representative*

- A. If Owner and Engineer agree, Engineer will furnish a Resident Project Representative to assist Engineer in providing more extensive observation of the Work. The authority and responsibilities of any such Resident Project Representative and assistants will be as provided in the Supplementary Conditions, and limitations on the responsibilities thereof will be as provided in Paragraph 9.09. If Owner designates another representative or agent to represent Owner at the Site who is not Engineer's consultant, agent or employee, the responsibilities and authority and limitations thereon of such other individual or entity will be as provided in the Supplementary Conditions.

9.04 *Authorized Variations in Work*

- A. Engineer may authorize minor variations in the Work from the requirements of the Contract Documents which do not involve an adjustment in the Contract Price or the Contract Times and are compatible with the design concept of the completed Project as a functioning whole as indicated by the Contract Documents. These may be accomplished by a Field Order and will be binding on Owner and also on Contractor, who shall perform the Work involved promptly. If Owner or Contractor believes that a Field Order justifies an adjustment in the Contract Price or Contract Times, or both, and the parties are unable to agree on entitlement to or on the amount or extent, if any, of any such adjustment, a Claim may be made therefor as provided in Paragraph 10.05.

9.05 *Rejecting Defective Work*

- A. Engineer will have authority to reject Work which Engineer believes to be defective, or that Engineer believes will not produce a completed Project that conforms to the Contract Documents or that will prejudice the integrity of the design concept of the completed Project as a functioning whole as indicated by the Contract Documents. Engineer will also have authority to require special inspection or testing of the Work as provided in Paragraph 13.04, whether or not the Work is fabricated, installed, or completed.

9.06 *Shop Drawings, Change Orders and Payments*

- A. In connection with Engineer's authority, and limitations thereof, as to Shop Drawings and Samples, see Paragraph 6.17.
- B. In connection with Engineer's authority, and limitations thereof, as to design calculations and design drawings submitted in response to a delegation of professional design services, if any, see Paragraph 6.21.
- C. In connection with Engineer's authority as to Change Orders, see Articles 10, 11, and 12.
- D. In connection with Engineer's authority as to Applications for Payment, see Article 14.

9.07 *Determinations for Unit Price Work*

- A. Engineer will determine the actual quantities and classifications of Unit Price Work performed by Contractor. Engineer will review with Contractor the Engineer's preliminary determinations on such matters before rendering a written decision thereon (by recommendation of an Application for Payment or otherwise). Engineer's written decision thereon will be final and binding (except as modified by Engineer to reflect changed factual conditions or more accurate data) upon Owner and Contractor, subject to the provisions of Paragraph 10.05.

9.08 *Decisions on Requirements of Contract Documents and Acceptability of Work*

- A. Engineer will be the initial interpreter of the requirements of the Contract Documents and judge of the acceptability of the Work thereunder. All matters in question and other matters between Owner and Contractor arising prior to the date final payment is due relating to the acceptability of the Work, and the interpretation of the requirements of the Contract Documents pertaining to the performance of the Work, will be referred initially to Engineer in writing within 30 days of the event giving rise to the question.
- B. Engineer will, with reasonable promptness, render a written decision on the issue referred. If Owner or Contractor believes that any such decision entitles them to an adjustment in the Contract Price or Contract Times or both, a Claim may be made under Paragraph 10.05. The date of Engineer's decision shall be the date of the event giving rise to the issues referenced for the purposes of Paragraph 10.05.B.
- C. Engineer's written decision on the issue referred will be final and binding on Owner and Contractor, subject to the provisions of Paragraph 10.05.
- D. When functioning as interpreter and judge under this Paragraph 9.08, Engineer will not show partiality to Owner or Contractor and will not be liable in connection with any interpretation or decision rendered in good faith in such capacity.

9.09 *Limitations on Engineer's Authority and Responsibilities*

- A. Neither Engineer's authority or responsibility under this Article 9 or under any other provision of the Contract Documents nor any decision made by Engineer in good faith either to exercise or not exercise such authority or responsibility or the undertaking, exercise, or performance of any authority or responsibility by Engineer shall create, impose, or give rise to any duty in contract, tort, or otherwise owed by Engineer to Contractor, any Subcontractor, any Supplier, any other individual or entity, or to any surety for or employee or agent of any of them.
- B. Engineer will not supervise, direct, control, or have authority over or be responsible for Contractor's means, methods, techniques, sequences, or procedures of construction, or the safety precautions and programs incident thereto, or for any failure of Contractor to comply with Laws and Regulations applicable to the performance of the Work. Engineer will not be responsible for Contractor's failure to perform the Work in accordance with the Contract Documents.
- C. Engineer will not be responsible for the acts or omissions of Contractor or of any Subcontractor, any Supplier, or of any other individual or entity performing any of the Work.
- D. Engineer's review of the final Application for Payment and accompanying documentation and all maintenance and operating instructions, schedules, guarantees, bonds, certificates of inspection, tests and approvals, and other documentation required to be delivered by Paragraph 14.07.A will only be to determine generally that their content complies with the requirements of, and in the case of certificates of

inspections, tests, and approvals that the results certified indicate compliance with, the Contract Documents.

- E. The limitations upon authority and responsibility set forth in this Paragraph 9.09 shall also apply to the Resident Project Representative, if any, and assistants, if any.

9.10 *Compliance with Safety Program*

- A. While at the Site, Engineer's employees and representatives shall comply with the specific applicable requirements of Contractor's safety programs of which Engineer has been informed pursuant to Paragraph 6.13.D.

ARTICLE 10 – CHANGES IN THE WORK; CLAIMS

10.01 *Authorized Changes in the Work*

- A. Without invalidating the Contract and without notice to any surety, Owner may, at any time or from time to time, order additions, deletions, or revisions in the Work by a Change Order, or a Work Change Directive. Upon receipt of any such document, Contractor shall promptly proceed with the Work involved which will be performed under the applicable conditions of the Contract Documents (except as otherwise specifically provided).
- B. If Owner and Contractor are unable to agree on entitlement to, or on the amount or extent, if any, of an adjustment in the Contract Price or Contract Times, or both, that should be allowed as a result of a Work Change Directive, a Claim may be made therefor as provided in Paragraph 10.05.

10.02 *Unauthorized Changes in the Work*

- A. Contractor shall not be entitled to an increase in the Contract Price or an extension of the Contract Times with respect to any work performed that is not required by the Contract Documents as amended, modified, or supplemented as provided in Paragraph 3.04, except in the case of an emergency as provided in Paragraph 6.16 or in the case of uncovering Work as provided in Paragraph 13.04.D.

10.03 *Execution of Change Orders*

- A. Owner and Contractor shall execute appropriate Change Orders recommended by Engineer covering:
 - 1. changes in the Work which are: (i) ordered by Owner pursuant to Paragraph 10.01.A, (ii) required because of acceptance of defective Work under Paragraph 13.08.A or Owner's correction of defective Work under Paragraph 13.09, or (iii) agreed to by the parties;
 - 2. changes in the Contract Price or Contract Times which are agreed to by the parties, including any undisputed sum or amount of time for Work actually performed in accordance with a Work Change Directive; and
 - 3. changes in the Contract Price or Contract Times which embody the substance of any written decision rendered by Engineer pursuant to Paragraph 10.05; provided that, in lieu of executing any such Change Order, an appeal may be taken from any such decision in accordance with the provisions of the Contract Documents and applicable Laws and Regulations, but during any such appeal, Contractor shall carry on the Work and adhere to the Progress Schedule as provided in Paragraph 6.18.A.

10.04 *Notification to Surety*

- A. If the provisions of any bond require notice to be given to a surety of any change affecting the general scope of the Work or the provisions of the Contract Documents (including, but not limited to, Contract Price or Contract Times), the giving of any such notice will be Contractor's responsibility. The amount of each applicable bond will be adjusted to reflect the effect of any such change.

10.05 *Claims*

- A. *Engineer's Decision Required:* All Claims, except those waived pursuant to Paragraph 14.09, shall be referred to the Engineer for decision. A decision by Engineer shall be required as a condition precedent to any exercise by Owner or Contractor of any rights or remedies either may otherwise have under the Contract Documents or by Laws and Regulations in respect of such Claims.
- B. *Notice:* Written notice stating the general nature of each Claim shall be delivered by the claimant to Engineer and the other party to the Contract promptly (but in no event later than 30 days) after the start of the event giving rise thereto. The responsibility to substantiate a Claim shall rest with the party making the Claim. Notice of the amount or extent of the Claim, with supporting data shall be delivered to the Engineer and the other party to the Contract within 60 days after the start of such event (unless Engineer allows additional time for claimant to submit additional or more accurate data in support of such Claim). A Claim for an adjustment in Contract Price shall be prepared in accordance with the provisions of Paragraph 12.01.B. A Claim for an adjustment in Contract Times shall be prepared in accordance with the provisions of Paragraph 12.02.B. Each Claim shall be accompanied by claimant's written statement that the adjustment claimed is the entire adjustment to which the claimant believes it is entitled as a result of said event. The opposing party shall submit any response to Engineer and the claimant within 30 days after receipt of the claimant's last submittal (unless Engineer allows additional time).
- C. *Engineer's Action:* Engineer will review each Claim and, within 30 days after receipt of the last submittal of the claimant or the last submittal of the opposing party, if any, take one of the following actions in writing:
 - 1. deny the Claim in whole or in part;
 - 2. approve the Claim; or
 - 3. notify the parties that the Engineer is unable to resolve the Claim if, in the Engineer's sole discretion, it would be inappropriate for the Engineer to do so. For purposes of further resolution of the Claim, such notice shall be deemed a denial.
- D. In the event that Engineer does not take action on a Claim within said 30 days, the Claim shall be deemed denied.
- E. Engineer's written action under Paragraph 10.05.C or denial pursuant to Paragraphs 10.05.C.3 or 10.05.D will be final and binding upon Owner and Contractor, unless Owner or Contractor invoke the dispute resolution procedure set forth in Article 16 within 30 days of such action or denial.
- F. No Claim for an adjustment in Contract Price or Contract Times will be valid if not submitted in accordance with this Paragraph 10.05.

ARTICLE 11 – COST OF THE WORK; ALLOWANCES; UNIT PRICE WORK

11.01 *Cost of the Work*

A. *Costs Included:* The term Cost of the Work means the sum of all costs, except those excluded in Paragraph 11.01.B, necessarily incurred and paid by Contractor in the proper performance of the Work. When the value of any Work covered by a Change Order or when a Claim for an adjustment in Contract Price is determined on the basis of Cost of the Work, the costs to be reimbursed to Contractor will be only those additional or incremental costs required because of the change in the Work or because of the event giving rise to the Claim. Except as otherwise may be agreed to in writing by Owner, such costs shall be in amounts no higher than those prevailing in the locality of the Project, shall not include any of the costs itemized in Paragraph 11.01.B, and shall include only the following items:

1. Payroll costs for employees in the direct employ of Contractor in the performance of the Work under schedules of job classifications agreed upon by Owner and Contractor. Such employees shall include, without limitation, superintendents, foremen, and other personnel employed full time on the Work. Payroll costs for employees not employed full time on the Work shall be apportioned on the basis of their time spent on the Work. Payroll costs shall include, but not be limited to, salaries and wages plus the cost of fringe benefits, which shall include social security contributions, unemployment, excise, and payroll taxes, workers' compensation, health and retirement benefits, bonuses, sick leave, vacation and holiday pay applicable thereto. The expenses of performing Work outside of regular working hours, on Saturday, Sunday, or legal holidays, shall be included in the above to the extent authorized by Owner.
2. Cost of all materials and equipment furnished and incorporated in the Work, including costs of transportation and storage thereof, and Suppliers' field services required in connection therewith. All cash discounts shall accrue to Contractor unless Owner deposits funds with Contractor with which to make payments, in which case the cash discounts shall accrue to Owner. All trade discounts, rebates and refunds and returns from sale of surplus materials and equipment shall accrue to Owner, and Contractor shall make provisions so that they may be obtained.
3. Payments made by Contractor to Subcontractors for Work performed by Subcontractors. If required by Owner, Contractor shall obtain competitive bids from subcontractors acceptable to Owner and Contractor and shall deliver such bids to Owner, who will then determine, with the advice of Engineer, which bids, if any, will be acceptable. If any subcontract provides that the Subcontractor is to be paid on the basis of Cost of the Work plus a fee, the Subcontractor's Cost of the Work and fee shall be determined in the same manner as Contractor's Cost of the Work and fee as provided in this Paragraph 11.01.
4. Costs of special consultants (including but not limited to engineers, architects, testing laboratories, surveyors, attorneys, and accountants) employed for services specifically related to the Work.
5. Supplemental costs including the following:
 - a. The proportion of necessary transportation, travel, and subsistence expenses of Contractor's employees incurred in discharge of duties connected with the Work.
 - b. Cost, including transportation and maintenance, of all materials, supplies, equipment, machinery, appliances, office, and temporary facilities at the Site, and hand tools not owned by the workers, which are consumed in the performance of the Work, and cost, less market value, of such items used but not consumed which remain the property of Contractor.

- c. Rentals of all construction equipment and machinery, and the parts thereof whether rented from Contractor or others in accordance with rental agreements approved by Owner with the advice of Engineer, and the costs of transportation, loading, unloading, assembly, dismantling, and removal thereof. All such costs shall be in accordance with the terms of said rental agreements. The rental of any such equipment, machinery, or parts shall cease when the use thereof is no longer necessary for the Work.
- d. Sales, consumer, use, and other similar taxes related to the Work, and for which Contractor is liable, as imposed by Laws and Regulations.
- e. Deposits lost for causes other than negligence of Contractor, any Subcontractor, or anyone directly or indirectly employed by any of them or for whose acts any of them may be liable, and royalty payments and fees for permits and licenses.
- f. Losses and damages (and related expenses) caused by damage to the Work, not compensated by insurance or otherwise, sustained by Contractor in connection with the performance of the Work (except losses and damages within the deductible amounts of property insurance established in accordance with Paragraph 5.06.D), provided such losses and damages have resulted from causes other than the negligence of Contractor, any Subcontractor, or anyone directly or indirectly employed by any of them or for whose acts any of them may be liable. Such losses shall include settlements made with the written consent and approval of Owner. No such losses, damages, and expenses shall be included in the Cost of the Work for the purpose of determining Contractor's fee.
- g. The cost of utilities, fuel, and sanitary facilities at the Site.
- h. Minor expenses such as telegrams, long distance telephone calls, telephone service at the Site, express and courier services, and similar petty cash items in connection with the Work.
- i. The costs of premiums for all bonds and insurance Contractor is required by the Contract Documents to purchase and maintain.

B. *Costs Excluded:* The term Cost of the Work shall not include any of the following items:

- 1. Payroll costs and other compensation of Contractor's officers, executives, principals (of partnerships and sole proprietorships), general managers, safety managers, engineers, architects, estimators, attorneys, auditors, accountants, purchasing and contracting agents, expeditors, timekeepers, clerks, and other personnel employed by Contractor, whether at the Site or in Contractor's principal or branch office for general administration of the Work and not specifically included in the agreed upon schedule of job classifications referred to in Paragraph 11.01.A.1 or specifically covered by Paragraph 11.01.A.4, all of which are to be considered administrative costs covered by the Contractor's fee.
- 2. Expenses of Contractor's principal and branch offices other than Contractor's office at the Site.
- 3. Any part of Contractor's capital expenses, including interest on Contractor's capital employed for the Work and charges against Contractor for delinquent payments.
- 4. Costs due to the negligence of Contractor, any Subcontractor, or anyone directly or indirectly employed by any of them or for whose acts any of them may be liable, including but not limited to, the correction of defective Work, disposal of materials or equipment wrongly supplied, and making good any damage to property.

5. Other overhead or general expense costs of any kind and the costs of any item not specifically and expressly included in Paragraphs 11.01.A.
- C. *Contractor's Fee:* When all the Work is performed on the basis of cost-plus, Contractor's fee shall be determined as set forth in the Agreement. When the value of any Work covered by a Change Order or when a Claim for an adjustment in Contract Price is determined on the basis of Cost of the Work, Contractor's fee shall be determined as set forth in Paragraph 12.01.C.
- D. *Documentation:* Whenever the Cost of the Work for any purpose is to be determined pursuant to Paragraphs 11.01.A and 11.01.B, Contractor will establish and maintain records thereof in accordance with generally accepted accounting practices and submit in a form acceptable to Engineer an itemized cost breakdown together with supporting data.

11.02 Allowances

- A. It is understood that Contractor has included in the Contract Price all allowances so named in the Contract Documents and shall cause the Work so covered to be performed for such sums and by such persons or entities as may be acceptable to Owner and Engineer.
- B. *Cash Allowances:*
 1. Contractor agrees that:
 - a. the cash allowances include the cost to Contractor (less any applicable trade discounts) of materials and equipment required by the allowances to be delivered at the Site, and all applicable taxes; and
 - b. Contractor's costs for unloading and handling on the Site, labor, installation, overhead, profit, and other expenses contemplated for the cash allowances have been included in the Contract Price and not in the allowances, and no demand for additional payment on account of any of the foregoing will be valid.
- C. *Contingency Allowance:*
 1. Contractor agrees that a contingency allowance, if any, is for the sole use of Owner to cover unanticipated costs.
- D. Prior to final payment, an appropriate Change Order will be issued as recommended by Engineer to reflect actual amounts due Contractor on account of Work covered by allowances, and the Contract Price shall be correspondingly adjusted.

11.03 Unit Price Work

- A. Where the Contract Documents provide that all or part of the Work is to be Unit Price Work, initially the Contract Price will be deemed to include for all Unit Price Work an amount equal to the sum of the unit price for each separately identified item of Unit Price Work times the estimated quantity of each item as indicated in the Agreement.
- B. The estimated quantities of items of Unit Price Work are not guaranteed and are solely for the purpose of comparison of Bids and determining an initial Contract Price. Determinations of the actual quantities and classifications of Unit Price Work performed by Contractor will be made by Engineer subject to the provisions of Paragraph 9.07.

- C. Each unit price will be deemed to include an amount considered by Contractor to be adequate to cover Contractor's overhead and profit for each separately identified item.
- D. Owner or Contractor may make a Claim for an adjustment in the Contract Price in accordance with Paragraph 10.05 if:
 - 1. the quantity of any item of Unit Price Work performed by Contractor differs materially and significantly from the estimated quantity of such item indicated in the Agreement; and
 - 2. there is no corresponding adjustment with respect to any other item of Work; and
 - 3. Contractor believes that Contractor is entitled to an increase in Contract Price as a result of having incurred additional expense or Owner believes that Owner is entitled to a decrease in Contract Price and the parties are unable to agree as to the amount of any such increase or decrease.

ARTICLE 12 – CHANGE OF CONTRACT PRICE; CHANGE OF CONTRACT TIMES

12.01 *Change of Contract Price*

- A. The Contract Price may only be changed by a Change Order. Any Claim for an adjustment in the Contract Price shall be based on written notice submitted by the party making the Claim to the Engineer and the other party to the Contract in accordance with the provisions of Paragraph 10.05.
- B. The value of any Work covered by a Change Order or of any Claim for an adjustment in the Contract Price will be determined as follows:
 - 1. where the Work involved is covered by unit prices contained in the Contract Documents, by application of such unit prices to the quantities of the items involved (subject to the provisions of Paragraph 11.03); or
 - 2. where the Work involved is not covered by unit prices contained in the Contract Documents, by a mutually agreed lump sum (which may include an allowance for overhead and profit not necessarily in accordance with Paragraph 12.01.C.2); or
 - 3. where the Work involved is not covered by unit prices contained in the Contract Documents and agreement to a lump sum is not reached under Paragraph 12.01.B.2, on the basis of the Cost of the Work (determined as provided in Paragraph 11.01) plus a Contractor's fee for overhead and profit (determined as provided in Paragraph 12.01.C).
- C. *Contractor's Fee:* The Contractor's fee for overhead and profit shall be determined as follows:
 - 1. a mutually acceptable fixed fee; or
 - 2. if a fixed fee is not agreed upon, then a fee based on the following percentages of the various portions of the Cost of the Work:
 - a. for costs incurred under Paragraphs 11.01.A.1 and 11.01.A.2, the Contractor's fee shall be 15 percent;
 - b. for costs incurred under Paragraph 11.01.A.3, the Contractor's fee shall be five percent;

- c. where one or more tiers of subcontracts are on the basis of Cost of the Work plus a fee and no fixed fee is agreed upon, the intent of Paragraphs 12.01.C.2.a and 12.01.C.2.b is that the Subcontractor who actually performs the Work, at whatever tier, will be paid a fee of 15 percent of the costs incurred by such Subcontractor under Paragraphs 11.01.A.1 and 11.01.A.2 and that any higher tier Subcontractor and Contractor will each be paid a fee of five percent of the amount paid to the next lower tier Subcontractor;
- d. no fee shall be payable on the basis of costs itemized under Paragraphs 11.01.A.4, 11.01.A.5, and 11.01.B;
- e. the amount of credit to be allowed by Contractor to Owner for any change which results in a net decrease in cost will be the amount of the actual net decrease in cost plus a deduction in Contractor's fee by an amount equal to five percent of such net decrease; and
- f. when both additions and credits are involved in any one change, the adjustment in Contractor's fee shall be computed on the basis of the net change in accordance with Paragraphs 12.01.C.2.a through 12.01.C.2.e, inclusive.

12.02 *Change of Contract Times*

- A. The Contract Times may only be changed by a Change Order. Any Claim for an adjustment in the Contract Times shall be based on written notice submitted by the party making the Claim to the Engineer and the other party to the Contract in accordance with the provisions of Paragraph 10.05.
- B. Any adjustment of the Contract Times covered by a Change Order or any Claim for an adjustment in the Contract Times will be determined in accordance with the provisions of this Article 12.

12.03 *Delays*

- A. Where Contractor is prevented from completing any part of the Work within the Contract Times due to delay beyond the control of Contractor, the Contract Times will be extended in an amount equal to the time lost due to such delay if a Claim is made therefor as provided in Paragraph 12.02.A. Delays beyond the control of Contractor shall include, but not be limited to, acts or neglect by Owner, acts or neglect of utility owners or other contractors performing other work as contemplated by Article 7, fires, floods, epidemics, abnormal weather conditions, or acts of God.
- B. If Owner, Engineer, or other contractors or utility owners performing other work for Owner as contemplated by Article 7, or anyone for whom Owner is responsible, delays, disrupts, or interferes with the performance or progress of the Work, then Contractor shall be entitled to an equitable adjustment in the Contract Price or the Contract Times, or both. Contractor's entitlement to an adjustment of the Contract Times is conditioned on such adjustment being essential to Contractor's ability to complete the Work within the Contract Times.
- C. If Contractor is delayed in the performance or progress of the Work by fire, flood, epidemic, abnormal weather conditions, acts of God, acts or failures to act of utility owners not under the control of Owner, or other causes not the fault of and beyond control of Owner and Contractor, then Contractor shall be entitled to an equitable adjustment in Contract Times, if such adjustment is essential to Contractor's ability to complete the Work within the Contract Times. Such an adjustment shall be Contractor's sole and exclusive remedy for the delays described in this Paragraph 12.03.C.
- D. Owner, Engineer, and their officers, directors, members, partners, employees, agents, consultants, or subcontractors shall not be liable to Contractor for any claims, costs, losses, or damages (including but

not limited to all fees and charges of engineers, architects, attorneys, and other professionals and all court or arbitration or other dispute resolution costs) sustained by Contractor on or in connection with any other project or anticipated project.

- E. Contractor shall not be entitled to an adjustment in Contract Price or Contract Times for delays within the control of Contractor. Delays attributable to and within the control of a Subcontractor or Supplier shall be deemed to be delays within the control of Contractor.

ARTICLE 13 – TESTS AND INSPECTIONS; CORRECTION, REMOVAL OR ACCEPTANCE OF DEFECTIVE WORK

13.01 Notice of Defects

- A. Prompt notice of all defective Work of which Owner or Engineer has actual knowledge will be given to Contractor. Defective Work may be rejected, corrected, or accepted as provided in this Article 13.

13.02 Access to Work

- A. Owner, Engineer, their consultants and other representatives and personnel of Owner, independent testing laboratories, and governmental agencies with jurisdictional interests will have access to the Site and the Work at reasonable times for their observation, inspection, and testing. Contractor shall provide them proper and safe conditions for such access and advise them of Contractor's safety procedures and programs so that they may comply therewith as applicable.

13.03 Tests and Inspections

- A. Contractor shall give Engineer timely notice of readiness of the Work for all required inspections, tests, or approvals and shall cooperate with inspection and testing personnel to facilitate required inspections or tests.
- B. Owner shall employ and pay for the services of an independent testing laboratory to perform all inspections, tests, or approvals required by the Contract Documents except:
 - 1. for inspections, tests, or approvals covered by Paragraphs 13.03.C and 13.03.D below;
 - 2. that costs incurred in connection with tests or inspections conducted pursuant to Paragraph 13.04.B shall be paid as provided in Paragraph 13.04.C; and
 - 3. as otherwise specifically provided in the Contract Documents.
- C. If Laws or Regulations of any public body having jurisdiction require any Work (or part thereof) specifically to be inspected, tested, or approved by an employee or other representative of such public body, Contractor shall assume full responsibility for arranging and obtaining such inspections, tests, or approvals, pay all costs in connection therewith, and furnish Engineer the required certificates of inspection or approval.
- D. Contractor shall be responsible for arranging and obtaining and shall pay all costs in connection with any inspections, tests, or approvals required for Owner's and Engineer's acceptance of materials or equipment to be incorporated in the Work; or acceptance of materials, mix designs, or equipment submitted for approval prior to Contractor's purchase thereof for incorporation in the Work. Such inspections, tests, or approvals shall be performed by organizations acceptable to Owner and Engineer.

- E. If any Work (or the work of others) that is to be inspected, tested, or approved is covered by Contractor without written concurrence of Engineer, Contractor shall, if requested by Engineer, uncover such Work for observation.
- F. Uncovering Work as provided in Paragraph 13.03.E shall be at Contractor's expense unless Contractor has given Engineer timely notice of Contractor's intention to cover the same and Engineer has not acted with reasonable promptness in response to such notice.

13.04 *Uncovering Work*

- A. If any Work is covered contrary to the written request of Engineer, it must, if requested by Engineer, be uncovered for Engineer's observation and replaced at Contractor's expense.
- B. If Engineer considers it necessary or advisable that covered Work be observed by Engineer or inspected or tested by others, Contractor, at Engineer's request, shall uncover, expose, or otherwise make available for observation, inspection, or testing as Engineer may require, that portion of the Work in question, furnishing all necessary labor, material, and equipment.
- C. If it is found that the uncovered Work is defective, Contractor shall pay all claims, costs, losses, and damages (including but not limited to all fees and charges of engineers, architects, attorneys, and other professionals and all court or arbitration or other dispute resolution costs) arising out of or relating to such uncovering, exposure, observation, inspection, and testing, and of satisfactory replacement or reconstruction (including but not limited to all costs of repair or replacement of work of others); and Owner shall be entitled to an appropriate decrease in the Contract Price. If the parties are unable to agree as to the amount thereof, Owner may make a Claim therefor as provided in Paragraph 10.05.
- D. If the uncovered Work is not found to be defective, Contractor shall be allowed an increase in the Contract Price or an extension of the Contract Times, or both, directly attributable to such uncovering, exposure, observation, inspection, testing, replacement, and reconstruction. If the parties are unable to agree as to the amount or extent thereof, Contractor may make a Claim therefor as provided in Paragraph 10.05.

13.05 *Owner May Stop the Work*

- A. If the Work is defective, or Contractor fails to supply sufficient skilled workers or suitable materials or equipment, or fails to perform the Work in such a way that the completed Work will conform to the Contract Documents, Owner may order Contractor to stop the Work, or any portion thereof, until the cause for such order has been eliminated; however, this right of Owner to stop the Work shall not give rise to any duty on the part of Owner to exercise this right for the benefit of Contractor, any Subcontractor, any Supplier, any other individual or entity, or any surety for, or employee or agent of any of them.

13.06 *Correction or Removal of Defective Work*

- A. Promptly after receipt of written notice, Contractor shall correct all defective Work, whether or not fabricated, installed, or completed, or, if the Work has been rejected by Engineer, remove it from the Project and replace it with Work that is not defective. Contractor shall pay all claims, costs, losses, and damages (including but not limited to all fees and charges of engineers, architects, attorneys, and other professionals and all court or arbitration or other dispute resolution costs) arising out of or relating to such correction or removal (including but not limited to all costs of repair or replacement of work of others).

- B. When correcting defective Work under the terms of this Paragraph 13.06 or Paragraph 13.07, Contractor shall take no action that would void or otherwise impair Owner's special warranty and guarantee, if any, on said Work.

13.07 *Correction Period*

- A. If within one year after the date of Substantial Completion (or such longer period of time as may be prescribed by the terms of any applicable special guarantee required by the Contract Documents) or by any specific provision of the Contract Documents, any Work is found to be defective, or if the repair of any damages to the land or areas made available for Contractor's use by Owner or permitted by Laws and Regulations as contemplated in Paragraph 6.11.A is found to be defective, Contractor shall promptly, without cost to Owner and in accordance with Owner's written instructions:
 - 1. repair such defective land or areas; or
 - 2. correct such defective Work; or
 - 3. if the defective Work has been rejected by Owner, remove it from the Project and replace it with Work that is not defective, and
 - 4. satisfactorily correct or repair or remove and replace any damage to other Work, to the work of others or other land or areas resulting therefrom.
- B. If Contractor does not promptly comply with the terms of Owner's written instructions, or in an emergency where delay would cause serious risk of loss or damage, Owner may have the defective Work corrected or repaired or may have the rejected Work removed and replaced. All claims, costs, losses, and damages (including but not limited to all fees and charges of engineers, architects, attorneys, and other professionals and all court or arbitration or other dispute resolution costs) arising out of or relating to such correction or repair or such removal and replacement (including but not limited to all costs of repair or replacement of work of others) will be paid by Contractor.
- C. In special circumstances where a particular item of equipment is placed in continuous service before Substantial Completion of all the Work, the correction period for that item may start to run from an earlier date if so provided in the Specifications.
- D. Where defective Work (and damage to other Work resulting therefrom) has been corrected or removed and replaced under this Paragraph 13.07, the correction period hereunder with respect to such Work will be extended for an additional period of one year after such correction or removal and replacement has been satisfactorily completed.
- E. Contractor's obligations under this Paragraph 13.07 are in addition to any other obligation or warranty. The provisions of this Paragraph 13.07 shall not be construed as a substitute for, or a waiver of, the provisions of any applicable statute of limitation or repose.

13.08 *Acceptance of Defective Work*

- A. If, instead of requiring correction or removal and replacement of defective Work, Owner (and, prior to Engineer's recommendation of final payment, Engineer) prefers to accept it, Owner may do so. Contractor shall pay all claims, costs, losses, and damages (including but not limited to all fees and charges of engineers, architects, attorneys, and other professionals and all court or arbitration or other dispute resolution costs) attributable to Owner's evaluation of and determination to accept such defective Work (such costs to be approved by Engineer as to reasonableness) and for the diminished value of the

Work to the extent not otherwise paid by Contractor pursuant to this sentence. If any such acceptance occurs prior to Engineer's recommendation of final payment, a Change Order will be issued incorporating the necessary revisions in the Contract Documents with respect to the Work, and Owner shall be entitled to an appropriate decrease in the Contract Price, reflecting the diminished value of Work so accepted. If the parties are unable to agree as to the amount thereof, Owner may make a Claim therefor as provided in Paragraph 10.05. If the acceptance occurs after such recommendation, an appropriate amount will be paid by Contractor to Owner.

13.09 *Owner May Correct Defective Work*

- A. If Contractor fails within a reasonable time after written notice from Engineer to correct defective Work, or to remove and replace rejected Work as required by Engineer in accordance with Paragraph 13.06.A, or if Contractor fails to perform the Work in accordance with the Contract Documents, or if Contractor fails to comply with any other provision of the Contract Documents, Owner may, after seven days written notice to Contractor, correct, or remedy any such deficiency.
- B. In exercising the rights and remedies under this Paragraph 13.09, Owner shall proceed expeditiously. In connection with such corrective or remedial action, Owner may exclude Contractor from all or part of the Site, take possession of all or part of the Work and suspend Contractor's services related thereto, take possession of Contractor's tools, appliances, construction equipment and machinery at the Site, and incorporate in the Work all materials and equipment stored at the Site or for which Owner has paid Contractor but which are stored elsewhere. Contractor shall allow Owner, Owner's representatives, agents and employees, Owner's other contractors, and Engineer and Engineer's consultants access to the Site to enable Owner to exercise the rights and remedies under this Paragraph.
- C. All claims, costs, losses, and damages (including but not limited to all fees and charges of engineers, architects, attorneys, and other professionals and all court or arbitration or other dispute resolution costs) incurred or sustained by Owner in exercising the rights and remedies under this Paragraph 13.09 will be charged against Contractor, and a Change Order will be issued incorporating the necessary revisions in the Contract Documents with respect to the Work; and Owner shall be entitled to an appropriate decrease in the Contract Price. If the parties are unable to agree as to the amount of the adjustment, Owner may make a Claim therefor as provided in Paragraph 10.05. Such claims, costs, losses and damages will include but not be limited to all costs of repair, or replacement of work of others destroyed or damaged by correction, removal, or replacement of Contractor's defective Work.
- D. Contractor shall not be allowed an extension of the Contract Times because of any delay in the performance of the Work attributable to the exercise by Owner of Owner's rights and remedies under this Paragraph 13.09.

ARTICLE 14 – PAYMENTS TO CONTRACTOR AND COMPLETION

14.01 *Schedule of Values*

- A. The Schedule of Values established as provided in Paragraph 2.07.A will serve as the basis for progress payments and will be incorporated into a form of Application for Payment acceptable to Engineer. Progress payments on account of Unit Price Work will be based on the number of units completed.

14.02 *Progress Payments*

A. *Applications for Payments:*

1. At least 20 days before the date established in the Agreement for each progress payment (but not more often than once a month), Contractor shall submit to Engineer for review an Application for Payment filled out and signed by Contractor covering the Work completed as of the date of the Application and accompanied by such supporting documentation as is required by the Contract Documents. If payment is requested on the basis of materials and equipment not incorporated in the Work but delivered and suitably stored at the Site or at another location agreed to in writing, the Application for Payment shall also be accompanied by a bill of sale, invoice, or other documentation warranting that Owner has received the materials and equipment free and clear of all Liens and evidence that the materials and equipment are covered by appropriate property insurance or other arrangements to protect Owner's interest therein, all of which must be satisfactory to Owner.
2. Beginning with the second Application for Payment, each Application shall include an affidavit of Contractor stating that all previous progress payments received on account of the Work have been applied on account to discharge Contractor's legitimate obligations associated with prior Applications for Payment.
3. The amount of retainage with respect to progress payments will be as stipulated in the Agreement.

B. *Review of Applications:*

1. Engineer will, within 10 days after receipt of each Application for Payment, either indicate in writing a recommendation of payment and present the Application to Owner or return the Application to Contractor indicating in writing Engineer's reasons for refusing to recommend payment. In the latter case, Contractor may make the necessary corrections and resubmit the Application.
2. Engineer's recommendation of any payment requested in an Application for Payment will constitute a representation by Engineer to Owner, based on Engineer's observations of the executed Work as an experienced and qualified design professional, and on Engineer's review of the Application for Payment and the accompanying data and schedules, that to the best of Engineer's knowledge, information and belief:
 - a. the Work has progressed to the point indicated;
 - b. the quality of the Work is generally in accordance with the Contract Documents (subject to an evaluation of the Work as a functioning whole prior to or upon Substantial Completion, the results of any subsequent tests called for in the Contract Documents, a final determination of quantities and classifications for Unit Price Work under Paragraph 9.07, and any other qualifications stated in the recommendation); and
 - c. the conditions precedent to Contractor's being entitled to such payment appear to have been fulfilled in so far as it is Engineer's responsibility to observe the Work.
3. By recommending any such payment Engineer will not thereby be deemed to have represented that:
 - a. inspections made to check the quality or the quantity of the Work as it has been performed have been exhaustive, extended to every aspect of the Work in progress, or involved detailed inspections of the Work beyond the responsibilities specifically assigned to Engineer in the Contract Documents; or

- b. there may not be other matters or issues between the parties that might entitle Contractor to be paid additionally by Owner or entitle Owner to withhold payment to Contractor.
4. Neither Engineer's review of Contractor's Work for the purposes of recommending payments nor Engineer's recommendation of any payment, including final payment, will impose responsibility on Engineer:
- a. to supervise, direct, or control the Work, or
 - b. for the means, methods, techniques, sequences, or procedures of construction, or the safety precautions and programs incident thereto, or
 - c. for Contractor's failure to comply with Laws and Regulations applicable to Contractor's performance of the Work, or
 - d. to make any examination to ascertain how or for what purposes Contractor has used the moneys paid on account of the Contract Price, or
 - e. to determine that title to any of the Work, materials, or equipment has passed to Owner free and clear of any Liens.
5. Engineer may refuse to recommend the whole or any part of any payment if, in Engineer's opinion, it would be incorrect to make the representations to Owner stated in Paragraph 14.02.B.2. Engineer may also refuse to recommend any such payment or, because of subsequently discovered evidence or the results of subsequent inspections or tests, revise or revoke any such payment recommendation previously made, to such extent as may be necessary in Engineer's opinion to protect Owner from loss because:
- a. the Work is defective, or completed Work has been damaged, requiring correction or replacement;
 - b. the Contract Price has been reduced by Change Orders;
 - c. Owner has been required to correct defective Work or complete Work in accordance with Paragraph 13.09; or
 - d. Engineer has actual knowledge of the occurrence of any of the events enumerated in Paragraph 15.02.A.

C. Payment Becomes Due:

- 1. Ten days after presentation of the Application for Payment to Owner with Engineer's recommendation, the amount recommended will (subject to the provisions of Paragraph 14.02.D) become due, and when due will be paid by Owner to Contractor.

D. Reduction in Payment:

- 1. Owner may refuse to make payment of the full amount recommended by Engineer because:
 - a. claims have been made against Owner on account of Contractor's performance or furnishing of the Work;

- b. Liens have been filed in connection with the Work, except where Contractor has delivered a specific bond satisfactory to Owner to secure the satisfaction and discharge of such Liens;
 - c. there are other items entitling Owner to a set-off against the amount recommended; or
 - d. Owner has actual knowledge of the occurrence of any of the events enumerated in Paragraphs 14.02.B.5.a through 14.02.B.5.c or Paragraph 15.02.A.
2. If Owner refuses to make payment of the full amount recommended by Engineer, Owner will give Contractor immediate written notice (with a copy to Engineer) stating the reasons for such action and promptly pay Contractor any amount remaining after deduction of the amount so withheld. Owner shall promptly pay Contractor the amount so withheld, or any adjustment thereto agreed to by Owner and Contractor, when Contractor remedies the reasons for such action.
 3. Upon a subsequent determination that Owner's refusal of payment was not justified, the amount wrongfully withheld shall be treated as an amount due as determined by Paragraph 14.02.C.1 and subject to interest as provided in the Agreement.

14.03 *Contractor's Warranty of Title*

- A. Contractor warrants and guarantees that title to all Work, materials, and equipment covered by any Application for Payment, whether incorporated in the Project or not, will pass to Owner no later than the time of payment free and clear of all Liens.

14.04 *Substantial Completion*

- A. When Contractor considers the entire Work ready for its intended use Contractor shall notify Owner and Engineer in writing that the entire Work is substantially complete (except for items specifically listed by Contractor as incomplete) and request that Engineer issue a certificate of Substantial Completion.
- B. Promptly after Contractor's notification, Owner, Contractor, and Engineer shall make an inspection of the Work to determine the status of completion. If Engineer does not consider the Work substantially complete, Engineer will notify Contractor in writing giving the reasons therefor.
- C. If Engineer considers the Work substantially complete, Engineer will deliver to Owner a tentative certificate of Substantial Completion which shall fix the date of Substantial Completion. There shall be attached to the certificate a tentative list of items to be completed or corrected before final payment. Owner shall have seven days after receipt of the tentative certificate during which to make written objection to Engineer as to any provisions of the certificate or attached list. If, after considering such objections, Engineer concludes that the Work is not substantially complete, Engineer will, within 14 days after submission of the tentative certificate to Owner, notify Contractor in writing, stating the reasons therefor. If, after consideration of Owner's objections, Engineer considers the Work substantially complete, Engineer will, within said 14 days, execute and deliver to Owner and Contractor a definitive certificate of Substantial Completion (with a revised tentative list of items to be completed or corrected) reflecting such changes from the tentative certificate as Engineer believes justified after consideration of any objections from Owner.
- D. At the time of delivery of the tentative certificate of Substantial Completion, Engineer will deliver to Owner and Contractor a written recommendation as to division of responsibilities pending final payment between Owner and Contractor with respect to security, operation, safety, and protection of the Work, maintenance, heat, utilities, insurance, and warranties and guarantees. Unless Owner and Contractor agree otherwise in writing and so inform Engineer in writing prior to Engineer's issuing the definitive

certificate of Substantial Completion, Engineer's aforesaid recommendation will be binding on Owner and Contractor until final payment.

- E. Owner shall have the right to exclude Contractor from the Site after the date of Substantial Completion subject to allowing Contractor reasonable access to remove its property and complete or correct items on the tentative list.

14.05 *Partial Utilization*

- A. Prior to Substantial Completion of all the Work, Owner may use or occupy any substantially completed part of the Work which has specifically been identified in the Contract Documents, or which Owner, Engineer, and Contractor agree constitutes a separately functioning and usable part of the Work that can be used by Owner for its intended purpose without significant interference with Contractor's performance of the remainder of the Work, subject to the following conditions:
 - 1. Owner at any time may request Contractor in writing to permit Owner to use or occupy any such part of the Work which Owner believes to be ready for its intended use and substantially complete. If and when Contractor agrees that such part of the Work is substantially complete, Contractor, Owner, and Engineer will follow the procedures of Paragraph 14.04.A through D for that part of the Work.
 - 2. Contractor at any time may notify Owner and Engineer in writing that Contractor considers any such part of the Work ready for its intended use and substantially complete and request Engineer to issue a certificate of Substantial Completion for that part of the Work.
 - 3. Within a reasonable time after either such request, Owner, Contractor, and Engineer shall make an inspection of that part of the Work to determine its status of completion. If Engineer does not consider that part of the Work to be substantially complete, Engineer will notify Owner and Contractor in writing giving the reasons therefor. If Engineer considers that part of the Work to be substantially complete, the provisions of Paragraph 14.04 will apply with respect to certification of Substantial Completion of that part of the Work and the division of responsibility in respect thereof and access thereto.
 - 4. No use or occupancy or separate operation of part of the Work may occur prior to compliance with the requirements of Paragraph 5.10 regarding property insurance.

14.06 *Final Inspection*

- A. Upon written notice from Contractor that the entire Work or an agreed portion thereof is complete, Engineer will promptly make a final inspection with Owner and Contractor and will notify Contractor in writing of all particulars in which this inspection reveals that the Work is incomplete or defective. Contractor shall immediately take such measures as are necessary to complete such Work or remedy such deficiencies.

14.07 *Final Payment*

A. *Application for Payment:*

1. After Contractor has, in the opinion of Engineer, satisfactorily completed all corrections identified during the final inspection and has delivered, in accordance with the Contract Documents, all maintenance and operating instructions, schedules, guarantees, bonds, certificates or other evidence of insurance, certificates of inspection, marked-up record documents (as provided in Paragraph 6.12), and other documents, Contractor may make application for final payment following the procedure for progress payments.
2. The final Application for Payment shall be accompanied (except as previously delivered) by:
 - a. all documentation called for in the Contract Documents, including but not limited to the evidence of insurance required by Paragraph 5.04.B.6;
 - b. consent of the surety, if any, to final payment;
 - c. a list of all Claims against Owner that Contractor believes are unsettled; and
 - d. complete and legally effective releases or waivers (satisfactory to Owner) of all Lien rights arising out of or Liens filed in connection with the Work.
3. In lieu of the releases or waivers of Liens specified in Paragraph 14.07.A.2 and as approved by Owner, Contractor may furnish receipts or releases in full and an affidavit of Contractor that: (i) the releases and receipts include all labor, services, material, and equipment for which a Lien could be filed; and (ii) all payrolls, material and equipment bills, and other indebtedness connected with the Work for which Owner might in any way be responsible, or which might in any way result in liens or other burdens on Owner's property, have been paid or otherwise satisfied. If any Subcontractor or Supplier fails to furnish such a release or receipt in full, Contractor may furnish a bond or other collateral satisfactory to Owner to indemnify Owner against any Lien.

B. *Engineer's Review of Application and Acceptance:*

1. If, on the basis of Engineer's observation of the Work during construction and final inspection, and Engineer's review of the final Application for Payment and accompanying documentation as required by the Contract Documents, Engineer is satisfied that the Work has been completed and Contractor's other obligations under the Contract Documents have been fulfilled, Engineer will, within ten days after receipt of the final Application for Payment, indicate in writing Engineer's recommendation of payment and present the Application for Payment to Owner for payment. At the same time Engineer will also give written notice to Owner and Contractor that the Work is acceptable subject to the provisions of Paragraph 14.09. Otherwise, Engineer will return the Application for Payment to Contractor, indicating in writing the reasons for refusing to recommend final payment, in which case Contractor shall make the necessary corrections and resubmit the Application for Payment.

C. *Payment Becomes Due:*

1. Thirty days after the presentation to Owner of the Application for Payment and accompanying documentation, the amount recommended by Engineer, less any sum Owner is entitled to set off against Engineer's recommendation, including but not limited to liquidated damages, will become due and will be paid by Owner to Contractor.

14.08 *Final Completion Delayed*

- A. If, through no fault of Contractor, final completion of the Work is significantly delayed, and if Engineer so confirms, Owner shall, upon receipt of Contractor's final Application for Payment (for Work fully completed and accepted) and recommendation of Engineer, and without terminating the Contract, make payment of the balance due for that portion of the Work fully completed and accepted. If the remaining balance to be held by Owner for Work not fully completed or corrected is less than the retainage stipulated in the Agreement, and if bonds have been furnished as required in Paragraph 5.01, the written consent of the surety to the payment of the balance due for that portion of the Work fully completed and accepted shall be submitted by Contractor to Engineer with the Application for such payment. Such payment shall be made under the terms and conditions governing final payment, except that it shall not constitute a waiver of Claims.

14.09 *Waiver of Claims*

- A. The making and acceptance of final payment will constitute:
1. a waiver of all Claims by Owner against Contractor, except Claims arising from unsettled Liens, from defective Work appearing after final inspection pursuant to Paragraph 14.06, from failure to comply with the Contract Documents or the terms of any special guarantees specified therein, or from Contractor's continuing obligations under the Contract Documents; and
 2. a waiver of all Claims by Contractor against Owner other than those previously made in accordance with the requirements herein and expressly acknowledged by Owner in writing as still unsettled.

ARTICLE 15 – SUSPENSION OF WORK AND TERMINATION

15.01 *Owner May Suspend Work*

- A. At any time and without cause, Owner may suspend the Work or any portion thereof for a period of not more than 90 consecutive days by notice in writing to Contractor and Engineer which will fix the date on which Work will be resumed. Contractor shall resume the Work on the date so fixed. Contractor shall be granted an adjustment in the Contract Price or an extension of the Contract Times, or both, directly attributable to any such suspension if Contractor makes a Claim therefore as provided in Paragraph 10.05.

15.02 *Owner May Terminate for Cause*

- A. The occurrence of any one or more of the following events will justify termination for cause:
1. Contractor's persistent failure to perform the Work in accordance with the Contract Documents (including, but not limited to, failure to supply sufficient skilled workers or suitable materials or equipment or failure to adhere to the Progress Schedule established under Paragraph 2.07 as adjusted from time to time pursuant to Paragraph 6.04);
 2. Contractor's disregard of Laws or Regulations of any public body having jurisdiction;
 3. Contractor's repeated disregard of the authority of Engineer; or
 4. Contractor's violation in any substantial way of any provisions of the Contract Documents.
- B. If one or more of the events identified in Paragraph 15.02.A occur, Owner may, after giving Contractor (and surety) seven days written notice of its intent to terminate the services of Contractor:

1. exclude Contractor from the Site, and take possession of the Work and of all Contractor's tools, appliances, construction equipment, and machinery at the Site, and use the same to the full extent they could be used by Contractor (without liability to Contractor for trespass or conversion);
 2. incorporate in the Work all materials and equipment stored at the Site or for which Owner has paid Contractor but which are stored elsewhere; and
 3. complete the Work as Owner may deem expedient.
- C. If Owner proceeds as provided in Paragraph 15.02.B, Contractor shall not be entitled to receive any further payment until the Work is completed. If the unpaid balance of the Contract Price exceeds all claims, costs, losses, and damages (including but not limited to all fees and charges of engineers, architects, attorneys, and other professionals and all court or arbitration or other dispute resolution costs) sustained by Owner arising out of or relating to completing the Work, such excess will be paid to Contractor. If such claims, costs, losses, and damages exceed such unpaid balance, Contractor shall pay the difference to Owner. Such claims, costs, losses, and damages incurred by Owner will be reviewed by Engineer as to their reasonableness and, when so approved by Engineer, incorporated in a Change Order. When exercising any rights or remedies under this Paragraph, Owner shall not be required to obtain the lowest price for the Work performed.
- D. Notwithstanding Paragraphs 15.02.B and 15.02.C, Contractor's services will not be terminated if Contractor begins within seven days of receipt of notice of intent to terminate to correct its failure to perform and proceeds diligently to cure such failure within no more than 30 days of receipt of said notice.
- E. Where Contractor's services have been so terminated by Owner, the termination will not affect any rights or remedies of Owner against Contractor then existing or which may thereafter accrue. Any retention or payment of moneys due Contractor by Owner will not release Contractor from liability.
- F. If and to the extent that Contractor has provided a performance bond under the provisions of Paragraph 5.01.A, the termination procedures of that bond shall supersede the provisions of Paragraphs 15.02.B and 15.02.C.

15.03 *Owner May Terminate For Convenience*

- A. Upon seven days written notice to Contractor and Engineer, Owner may, without cause and without prejudice to any other right or remedy of Owner, terminate the Contract. In such case, Contractor shall be paid for (without duplication of any items):
1. completed and acceptable Work executed in accordance with the Contract Documents prior to the effective date of termination, including fair and reasonable sums for overhead and profit on such Work;
 2. expenses sustained prior to the effective date of termination in performing services and furnishing labor, materials, or equipment as required by the Contract Documents in connection with uncompleted Work, plus fair and reasonable sums for overhead and profit on such expenses;
 3. all claims, costs, losses, and damages (including but not limited to all fees and charges of engineers, architects, attorneys, and other professionals and all court or arbitration or other dispute resolution costs) incurred in settlement of terminated contracts with Subcontractors, Suppliers, and others; and
 4. reasonable expenses directly attributable to termination.

- B. Contractor shall not be paid on account of loss of anticipated profits or revenue or other economic loss arising out of or resulting from such termination.

15.04 *Contractor May Stop Work or Terminate*

- A. If, through no act or fault of Contractor, (i) the Work is suspended for more than 90 consecutive days by Owner or under an order of court or other public authority, or (ii) Engineer fails to act on any Application for Payment within 30 days after it is submitted, or (iii) Owner fails for 30 days to pay Contractor any sum finally determined to be due, then Contractor may, upon seven days written notice to Owner and Engineer, and provided Owner or Engineer do not remedy such suspension or failure within that time, terminate the Contract and recover from Owner payment on the same terms as provided in Paragraph 15.03.
- B. In lieu of terminating the Contract and without prejudice to any other right or remedy, if Engineer has failed to act on an Application for Payment within 30 days after it is submitted, or Owner has failed for 30 days to pay Contractor any sum finally determined to be due, Contractor may, seven days after written notice to Owner and Engineer, stop the Work until payment is made of all such amounts due Contractor, including interest thereon. The provisions of this Paragraph 15.04 are not intended to preclude Contractor from making a Claim under Paragraph 10.05 for an adjustment in Contract Price or Contract Times or otherwise for expenses or damage directly attributable to Contractor's stopping the Work as permitted by this Paragraph.

ARTICLE 16 – DISPUTE RESOLUTION

16.01 *Methods and Procedures*

- A. Either Owner or Contractor may request mediation of any Claim submitted to Engineer for a decision under Paragraph 10.05 before such decision becomes final and binding. The mediation will be governed by the Construction Industry Mediation Rules of the American Arbitration Association in effect as of the Effective Date of the Agreement. The request for mediation shall be submitted in writing to the American Arbitration Association and the other party to the Contract. Timely submission of the request shall stay the effect of Paragraph 10.05.E.
- B. Owner and Contractor shall participate in the mediation process in good faith. The process shall be concluded within 60 days of filing of the request. The date of termination of the mediation shall be determined by application of the mediation rules referenced above.
- C. If the Claim is not resolved by mediation, Engineer's action under Paragraph 10.05.C or a denial pursuant to Paragraphs 10.05.C.3 or 10.05.D shall become final and binding 30 days after termination of the mediation unless, within that time period, Owner or Contractor:
 - 1. elects in writing to invoke any dispute resolution process provided for in the Supplementary Conditions; or
 - 2. agrees with the other party to submit the Claim to another dispute resolution process; or
 - 3. gives written notice to the other party of the intent to submit the Claim to a court of competent jurisdiction.

ARTICLE 17 – MISCELLANEOUS

17.01 *Giving Notice*

- A. Whenever any provision of the Contract Documents requires the giving of written notice, it will be deemed to have been validly given if:
 - 1. delivered in person to the individual or to a member of the firm or to an officer of the corporation for whom it is intended; or
 - 2. delivered at or sent by registered or certified mail, postage prepaid, to the last business address known to the giver of the notice.

17.02 *Computation of Times*

- A. When any period of time is referred to in the Contract Documents by days, it will be computed to exclude the first and include the last day of such period. If the last day of any such period falls on a Saturday or Sunday or on a day made a legal holiday by the law of the applicable jurisdiction, such day will be omitted from the computation.

17.03 *Cumulative Remedies*

- A. The duties and obligations imposed by these General Conditions and the rights and remedies available hereunder to the parties hereto are in addition to, and are not to be construed in any way as a limitation of, any rights and remedies available to any or all of them which are otherwise imposed or available by Laws or Regulations, by special warranty or guarantee, or by other provisions of the Contract Documents. The provisions of this Paragraph will be as effective as if repeated specifically in the Contract Documents in connection with each particular duty, obligation, right, and remedy to which they apply.

17.04 *Survival of Obligations*

- A. All representations, indemnifications, warranties, and guarantees made in, required by, or given in accordance with the Contract Documents, as well as all continuing obligations indicated in the Contract Documents, will survive final payment, completion, and acceptance of the Work or termination or completion of the Contract or termination of the services of Contractor.

17.05 *Controlling Law*

- A. This Contract is to be governed by the law of the state in which the Project is located.

17.06 *Headings*

- A. Article and paragraph headings are inserted for convenience only and do not constitute parts of these General Conditions.

These Supplementary Conditions amend or supplement the Standard General Conditions of the Construction Contract, EJCDC C-700 (2007 Edition). All provisions which are not so amended or supplemented remain in full force and effect.

The terms used in these Supplementary Conditions have the meanings stated in the General Conditions. Additional terms used in these Supplementary Conditions have the meanings stated below, which are applicable to both the singular and plural thereof.

The address system used in these Supplementary Conditions is the same as the address system used in the General Conditions, with the prefix "SC" added thereto.

SC-2.02 *Copies of Documents*

SC-2.02 Delete Paragraph 2.02.A in its entirety and insert the following in its place:

- A. Owner shall furnish to Contractor up to 2 printed or hard copies of the Drawings and Project Manual and one set in electronic format. Additional copies will be furnished upon request at the cost of reproduction.

SC-4.02 *Subsurface and Physical Conditions*

SC-4.02 Delete Paragraphs 4.02.A and 4.02.B in their entirety and insert the following:

- A. No reports of explorations or tests of subsurface conditions at or contiguous to the Site, or drawings of physical conditions relating to existing surface or subsurface structures at the Site, are known to Owner.

SC-4.05 *Reference Points*

SC-4.05 Delete Paragraph 4.05 A in its entirety and insert the following:

- A. Owner shall provide engineering surveys to establish reference points and offsets for construction which in Engineer's judgment are necessary to enable Contractor to proceed with the Work. Contractor shall be responsible for laying out the Work, shall protect and preserve the established reference points, offsets, and property monuments, and shall make no changes or relocations without the prior written approval of Owner. Contractor shall report to Engineer whenever any reference point, offsets or property monument is lost or destroyed or requires relocation because of necessary changes in grades or locations, and shall be responsible for the accurate replacement or relocation of such reference points, offsets, or property monuments by professionally qualified personnel.

SC-4.06 *Hazardous Environmental Conditions*

SC-4.06 Delete Paragraphs 4.06.A and 4.06.B in their entirety and insert the following:

A. No reports or drawings related to Hazardous Environmental Conditions at the Site are known to Owner.

B. Not Used.

SC-5.04 *Contractor's Liability Insurance*

SC-5.04 Add the following new paragraph immediately after Paragraph 5.04.B:

C. The limits of liability for the insurance required by Paragraph 5.04 of the General Conditions shall provide coverage for not less than the following amounts or greater where required by Laws and Regulations:

1. Workers' Compensation, and related coverages under Paragraphs 5.04.A.1 and A.2 of the General Conditions:

- a. State: Statutory
- b. Applicable Federal (e.g., Longshoreman's): Statutory
- c. Employer's Liability: \$ 500,000

2. Contractor's General Liability under Paragraphs 5.04.A.3 through A.6 of the General Conditions which shall include completed operations and product liability coverages and eliminate the exclusion with respect to property under the care, custody and control of Contractor:

- a. General Aggregate \$1,000,000
- b. Products - Completed Operations Aggregate \$ 500,000
- c. Personal and Advertising Injury \$1,000,000
- d. Each Occurrence (Bodily Injury and Property Damage) \$1,000,000
- e. Property Damage liability insurance will provide Explosion, Collapse, and Under-ground coverages where applicable.
- f. Excess or Umbrella Liability
 - General Aggregate \$1,000,000

Each Occurrence \$1,000,000

3. Automobile Liability under Paragraph 5.04.A.6 of the General Conditions:

- a. Bodily Injury:
 - Each person \$ 500,000
 - Each accident \$1,000,000
- b. Property Damage:
 - Each Accident \$500,000

[or]

- a. Combined Single Limit of \$500,000

4. The Contractual Liability coverage required by Paragraph 5.04.B.4 of the General Conditions shall provide coverage for not less than the following amounts:

- a. Bodily Injury:
 - Each person \$1,000,000
 - Each Accident \$1,000,000
- b. Property Damage:
 - Each Accident \$500,000
 - Annual Aggregate \$500,000

5. The Owner, and Clapsaddle-Garber Associates Inc. shall be named as additional insured.

SC-5.06 *Property Insurance*

GC-5.06.A.1 refers to other individuals or entities that are to be identified in SCs as being entitled to protection as loss payees under the property insurance on the Work. In such cases use the following:

SC-5.06.A.1 Add the following new subparagraph after subparagraph GC-5.06.A.1:

- a. In addition to the individuals and entities specified, include as loss payees the following: The Owner, and Clapsaddle-Garber Associates, Inc. shall be named as additional insured.

SC-6.06 *Concerning Subcontractors, Suppliers, and Others*

SC-6.06 Add a new paragraph immediately after Paragraph 6.06.G:

- H. Owner may furnish to any Subcontractor or Supplier, to the extent practicable, information about amounts paid to Contractor on account of Work performed for Contractor by a particular Subcontractor or Supplier.

SC-6.17 *Shop Drawings and Samples*

SC-6.17 Add the following new paragraphs immediately after Paragraph 6.17.E:

- F. Contractor shall furnish required submittals with sufficient information and accuracy in order to obtain required approval of an item with no more than three submittals. Engineer will record Engineer's time for reviewing subsequent submittals of Shop Drawings, samples, or other items requiring approval and Contractor shall reimburse Owner for Engineer's charges for such time.
- G. In the event that Contractor requests a change of a previously approved item, Contractor shall reimburse Owner for Engineer's charges for its review time unless the need for such change is beyond the control of Contractor.

SC-9.03 *Project Representative*

As indicated in GC-9.03, in those cases in which the Engineer will provide a Resident Project Representative (RPR) during construction, the authority and responsibilities of the RPR and any assistants must be specified in the Supplementary Conditions; thus this is a mandatory Supplementary Condition in such cases. The following suggested language which parallels the working of Exhibit D to EJCDC E-500, the Standard Form of Agreement Between Owner and Engineer for Professional Services, should be edited to indicate the RPR authority and responsibilities that apply to this project:

SC-9.03 Add the following new paragraphs immediately after Paragraph 9.03.A:

- B. The Resident Project Representative (RPR) will be Engineer's employee or agent at the Site, will act as directed by and under the supervision of Engineer, and will confer with Engineer regarding RPR's actions. RPR's dealings in matters pertaining to the Work in general shall be with Engineer and Contractor. RPR's dealings with Subcontractors shall be through or with the full knowledge and approval of Contractor. The RPR shall:
 - 1. *Schedules:* Review the progress schedule, schedule of Shop Drawing and Sample submittals, and schedule of values prepared by Contractor and consult with Engineer concerning acceptability.
 - 2. *Conferences and Meetings:* Attend meetings with Contractor, such as preconstruction conferences, progress meetings, job conferences and other project-related meetings, and prepare and circulate copies of minutes thereof.
 - 3. *Liaison:*

- a. Serve as Engineer's liaison with Contractor, working principally through Contractor's authorized representative, assist in providing information regarding the intent of the Contract Documents.
 - b. Assist Engineer in serving as Owner's liaison with Contractor when Contractor's operations affect Owner's on-Site operations.
 - c. Assist in obtaining from Owner additional details or information, when required for proper execution of the Work.
4. *Interpretation of Contract Documents:* Report to Engineer when clarifications and interpretations of the Contract Documents are needed and transmit to Contractor clarifications and interpretations as issued by Engineer.
5. *Shop Drawings and Samples:*
- a. Record date of receipt of Samples and approved Shop Drawings.
 - b. Receive Samples which are furnished at the Site by Contractor, and notify Engineer of availability of Samples for examination.
6. *Modifications:* Consider and evaluate Contractor's suggestions for modifications in Drawings or Specifications and report such suggestions, together with RPR's recommendations, to Engineer. Transmit to Contractor in writing decisions as issued by Engineer.
7. *Review of Work and Rejection of Defective Work:*
- a. Conduct on-Site observations of Contractor's work in progress to assist Engineer in determining if the Work is in general proceeding in accordance with the Contract Documents.
 - b. Report to Engineer whenever RPR believes that any part of Contractor's work in progress will not produce a completed Project that conforms generally to the Contract Documents or will imperil the integrity of the design concept of the completed Project as a functioning whole as indicated in the Contract Documents, or has been damaged, or does not meet the requirements of any inspection, test or approval required to be made; and advise Engineer of that part of work in progress that RPR believes should be corrected or rejected or should be uncovered for observation, or requires special testing, inspection or approval.
8. *Inspections, Tests, and System Startups:*
- a. Verify that tests, equipment, and systems start-ups and operating and maintenance training are conducted in the presence of appropriate Owner's personnel, and that Contractor maintains adequate records thereof.

- b. Observe, record, and report to Engineer appropriate details relative to the test procedures and systems start-ups.

9. *Records:*

- a. Record names, addresses, fax numbers, e-mail addresses, web site locations, and telephone numbers of all Contractors, Subcontractors, and major Suppliers of materials and equipment.
- b. Maintain records for use in preparing Project documentation.

10. *Reports:*

- a. Furnish to Engineer periodic reports as required of progress of the Work and of Contractor's compliance with the progress schedule and schedule of Shop Drawing and Sample submittals.
- b. Draft and recommend to Engineer proposed Change Orders, Work Change Directives, and Field Orders. Obtain backup material from Contractor.
- c. Immediately notify Engineer of the occurrence of any Site accidents, emergencies, acts of God endangering the Work, damage to property by fire or other causes, or the discovery of any Hazardous Environmental Condition.

11. *Payment Requests:* Review Applications for Payment with Contractor for compliance with the established procedure for their submission and forward with recommendations to Engineer, noting particularly the relationship of the payment requested to the schedule of values, Work completed, and materials and equipment delivered at the Site but not incorporated in the Work.

12. *Certificates, Operation and Maintenance Manuals:* During the course of the Work, verify that materials and equipment certificates, operation and maintenance manuals and other data required by the Specifications to be assembled and furnished by Contractor are applicable to the items actually installed and in accordance with the Contract Documents, and have these documents delivered to Engineer for review and forwarding to Owner prior to payment for that part of the Work.

13. *Completion:*

- a. Participate in a Substantial Completion inspection, assist in the determination of Substantial Completion and the preparation of lists of items to be completed or corrected.
- b. Participate in a final inspection in the company of Engineer, Owner, and Contractor and prepare a final list of items to be completed and deficiencies to be remedied.

- c. Observe whether all items on the final list have been completed or corrected and make recommendations to Engineer concerning acceptance and issuance of the Notice of Acceptability of the Work.

C. The RPR shall not:

1. Authorize any deviation from the Contract Documents or substitution of materials or equipment (including “or-equal” items).
2. Exceed limitations of Engineer’s authority as set forth in the Contract Documents.
3. Undertake any of the responsibilities of Contractor, Subcontractors, Suppliers, or Contractor’s superintendent.
4. Advise on, issue directions relative to, or assume control over any aspect of the means, methods, techniques, sequences or procedures of Contractor’s work unless such advice or directions are specifically required by the Contract Documents.
5. Advise on, issue directions regarding, or assume control over safety practices, precautions, and programs in connection with the activities or operations of Owner or Contractor.
6. Participate in specialized field or laboratory tests or inspections conducted off-site by others except as specifically authorized by Engineer.
7. Accept Shop Drawing or Sample submittals from anyone other than Contractor.
8. Authorize Owner to occupy the Project in whole or in part.

SC-11.03 *Unit Price Work*

SC-11.03.B Add the following sentence immediately after the last sentence of the paragraph.

Owner and Engineer reserve the right to adjust quantities.

SC-11.03.D Delete Paragraph 11.03.D in its entirety and insert the following in its place:

D. The unit price of an item of Unit Price Work shall be subject to reevaluation and adjustment under the following conditions:

1. if the Bid price of a particular item of Unit Price Work amounts to 10 percent or more of the Contract Price and the variation in the quantity of that particular item of Unit Price Work performed by Contractor differs by more than 25 percent from the estimated quantity of such item indicated in the Agreement; and

2. if there is no corresponding adjustment with respect to any other item of Work; and
3. if Contractor believes that Contractor has incurred additional expense as a result thereof or if Owner believes that the quantity variation entitles Owner to an adjustment in the unit price, either Owner or Contractor may make a Claim for an adjustment in the Contract Price in accordance with Article 10 if the parties are unable to agree as to the effect of any such variations in the quantity of Unit Price Work performed.

SC-16.01 *Methods and Procedure*

As an alternative to the dispute resolution process set forth in the General Conditions (mediation followed by litigation), the contract could pair final and binding arbitration with mediation. A discussion of the pros and cons of the arbitration process (and there are many advocates on either side) is beyond the scope of this Guide. Consultation with the Owner's legal counsel is highly recommended. Users should also note that they will need to insert the name of an arbitration agency, such as the American Arbitration Association or the CPR Institute for Dispute Resolution, in SC-16.02.A. The mediation/arbitration option requires the following:

SC-16.01 Delete Paragraph 16.01.C in its entirety and insert the following in its place:

- C. If the Claim is not resolved by mediation, Engineer's action under Paragraph 10.05.C or a denial pursuant to Paragraphs 10.05.C.3 or 10.05.D shall become final and binding 30 days after termination of the mediation unless, within that time period, Owner or Contractor:
 1. elects in writing to demand arbitration of the Claim, pursuant to Paragraph SC-16.02; or
 2. agrees with the other party to submit the Claim to another dispute resolution process.

SC-16.02 Add the following new paragraph immediately after Paragraph 16.01.

SC-16.02 *Arbitration*

- A. All Claims or counterclaims, disputes, or other matters in question between Owner and Contractor arising out of or relating to the Contract Documents or the breach thereof (except for Claims which have been waived by the making or acceptance of final payment as provided by Paragraph 14.09) including but not limited to those not resolved under the provisions of Paragraphs SC-16.01A and 16.01.B will be decided by arbitration in accordance with the rules of *[insert name of selected arbitration agency]*, subject to the conditions and limitations of this Paragraph SC-16.02. This agreement to arbitrate and any other agreement or consent to arbitrate entered into will be specifically enforceable under the prevailing law of any court having jurisdiction.
- B. The demand for arbitration will be filed in writing with the other party to the Contract and with the selected arbitrator or arbitration provider, and a copy

will be sent to Engineer for information. The demand for arbitration will be made within the 30 day period specified in Paragraph SC-16.01.C, and in all other cases within a reasonable time after the Claim or counterclaim, dispute, or other matter in question has arisen, and in no event shall any such demand be made after the date when institution of legal or equitable proceedings based on such Claim or other dispute or matter in question would be barred by the applicable statute of limitations.

- C. No arbitration arising out of or relating to the Contract Documents shall include by consolidation, joinder, or in any other manner any other individual or entity (including Engineer, and Engineer's consultants and the officers, directors, partners, agents, employees or consultants of any of them) who is not a party to this Contract unless:
 - 1. the inclusion of such other individual or entity is necessary if complete relief is to be afforded among those who are already parties to the arbitration; and
 - 2. such other individual or entity is substantially involved in a question of law or fact which is common to those who are already parties to the arbitration and which will arise in such proceedings.
- D. The award rendered by the arbitrator(s) shall be consistent with the agreement of the parties, in writing, and include: (i) a concise breakdown of the award; (ii) a written explanation of the award specifically citing the Contract Document provisions deemed applicable and relied on in making the award.
- E. The award will be final. Judgment may be entered upon it in any court having jurisdiction thereof, and it will not be subject to modification or appeal, subject to provisions of the Controlling Law relating to vacating or modifying an arbitral award.
- F. The fees and expenses of the arbitrators and any arbitration service shall be shared equally by Owner and Contractor.

ADMINISTRATIVE PROVISIONS

PART 1 GENERAL

1.01 WORK COVERED BY CONTRACT DOCUMENTS

- A. Work under this contract includes all work shown on the plans and described in these specifications.

1.02 AGREEMENT

- A. Construction work shall be by one separate unit priced agreement.

1.03 WORK SEQUENCE

- A. Work shall be done by the Contractor in accordance with a work schedule and sequence established by the Contractor. Work shall begin within 10 days of the Owner's Notice to Proceed, and work shall proceed continuously until complete.

1.04 CONTRACTOR USE OF PREMISES

- A. Limit use of premises to Work and construction operations, to allow for public access.
- B. Coordinate use of premises under direction of ENGINEER>

1.05 APPLICATION FOR PAYMENT

- A. Submit each application using the payment items listed in the Proposal.

1.06 COORDINATION

- A. Coordinate Work of various sections of Specifications to assure efficient and orderly sequence of installation of construction elements, with provisions for accommodating items installed later.
- B. Verify characteristics of elements of interrelated operating equipment are compatible; coordinate Work of various sections having interdependent responsibilities for installing, connecting to, and placing in service, such equipment.
- C. Execute cutting and patching to integrate elements of Work, uncover ill-timed, defective, and nonconforming work, provide openings for penetrations of existing surfaces, and provide samples for testing.

1.07 FIELD ENGINEERING

- A. Contractors shall be responsible for the layout of Work including setting exact grades, lines, and levels from Engineer provided offsets so that Work can be done in accordance with the plans.
- B. Control datum survey will be established by the OWNER. The OWNER will establish horizontal and vertical control through the project by locating control points and setting elevations at control points.

1.08 BUILDING CODES AND PERMITS

- A. CONTRACTOR shall obtain and pay for all construction permits and licenses. OWNER shall assist CONTRACTOR, when necessary, in obtaining such permits and licenses.
- B. Pay all government charges and inspection fees necessary for prosecution of Work, which are applicable at time of opening of Bids. Pay all charges of utility service companies for connections to Work. OWNER will pay all charges of such companies for capital costs related thereto.
- C. Give all notices and comply with all laws, ordinances, building and construction codes, rules, and regulations applicable to Work. If CONTRACTOR observes that Specifications or Drawings are at variance therewith, give ENGINEER prompt written notice thereof, and any necessary changes shall be adjusted by appropriate Modification.
- D. If CONTRACTOR performs any Work knowing or having reason to know that it is contrary to such laws, ordinances, rules, and regulations, and without such notice to ENGINEER, CONTRACTOR shall bear all costs arising therefrom; however, it shall not be CONTRACTOR'S primary responsibility to make certain that Specifications and Drawings are in accordance with such laws, ordinances, rules, and regulations.

1.09 TAXES

- A. Pay all sales, consumer, use and other similar taxes required to be paid by it in accordance with law of place of Project.

1.10 JOB SITE ADMINISTRATION

- A. CONTRACTOR shall provide competent, suitably qualified personnel to lay out Work and perform construction as required by Contract Documents. CONTRACTOR shall at all times maintain good discipline and order at site.
- B. Except in connection with safety or protection of persons or Work or property at site or adjacent thereto, and except as otherwise indicated in Contract Documents, all Work at site shall be performed during regular working hours, and CONTRACTOR shall not perform work outside of normal working hours without written authorization from owner.
- C. Incompetent or incorrigible employees shall be dismissed from Work by CONTRACTOR or its representative when requested by ENGINEER, and such persons shall not again be permitted to return to Work without written consent of ENGINEER.
- D. Workmanship shall be of best quality.

1.11 COPIES OF DRAWINGS AND PROJECT MANUALS

- A. After Notice of Award, CONTRACTOR may obtain, at no charge, maximum of 5 complete sets of full-size Drawings, as listed in project manual, and 5 sets of project manuals. Unless digital files are supplied. (See Supplementary Conditions)
- B. Additional copies of project manuals and full-size Drawings may be obtained under following conditions:
 - 1. Project Manuals:
 - a. Furnished at ENGINEER'S reproduction cost plus handling charge.
 - b. If CONTRACTOR'S requirement for additional project manuals necessitates reprinting of project manuals, CONTRACTOR shall pay entire cost of such reprinting.
 - c. Partial sets of project manuals will not be provided.

2. Full-size Drawings:
 - a. Complete sets of full-size Drawings may be purchased from ENGINEER at ENGINEER'S reproduction cost plus handling charge per set.
 - b. Complete sets of reproducible prints of full-size Drawings may be purchased from ENGINEER at ENGINEER'S reproduction cost plus handling charge per set.
- C. Revised Drawings and project manuals, if required, will be provided by ENGINEER to show authorized changes or extra Work under following conditions:
 1. Project Manuals: Furnished at no charge, in same quantity as original issuance.
 2. Full-size Drawings:
 - a. One revised, complete set of full-size Drawings will be issued, at no charge, for each full-size set originally issued.
 - b. One revised, complete set of full-size Drawings will be issued, at no charge, for each full-size set originally issued, and for each full-size set purchased by CONTRACTOR after Notice of Award, up to 4 copies maximum.
 - c. One full-size reproducible set will be issued to accommodate fifth and subsequent sets purchased by CONTRACTOR. CONTRACTOR shall use reproducible set to complete printing for additional Drawings in its possession.

1.12 REFERENCE STANDARDS

- A. For products specified by association or trade standards, comply with requirements of standard, except when more rigid requirements are specified or are required by applicable codes.
- B. Date of standard is that in effect as of Bid date, or date of Agreement when there are no Bids, except when specific date is specified.
- C. When required by individual Specifications Section, obtain copy of standard. Maintain copy at job site during submittals, planning, and progress of specific work, until Substantial Completion.
- D. Abbreviations used in Drawings and Specifications are as specified in ANSI Y1.1 and IEEE 260.

1.13 SCHEDULE OF REFERENCES

- A. AASHTO – American Association of State Highway and Transportation Officials.
- B. ASTM – American Society for Testing and Materials.
- C. OSHA – Occupational Safety and Health Administration.
- D. IDOT – Iowa Department of Transportation

1.14 QUALITY CONTROL, GENERAL

- A. Maintain quality control over suppliers, manufacturers, products, services, Site conditions, and workmanship, to produce Work of specified quality.

1.15 WORKMANSHIP

- A. Comply with industry standards except when more restrictive tolerances or specified requirements indicate more rigid standards or more precise workmanship.
- B. Perform Work by persons qualified to produce workmanship of specified quality.

- C. Secure products in place with positive anchorage devices designed and sized to withstand stresses, vibration, and racking.

1.16 MANUFACTURERS' INSTRUCTIONS

- A. Comply with instructions in full detail, including each step in sequence. Should instructions conflict with Contract Documents, request clarification from ENGINEER before proceeding.

1.17 MANUFACTURERS' CERTIFICATES

- A. When required by individual Specifications section, submit manufacturer's certificate, in duplicate, that products meet or exceed specified requirements.

1.18 CLOSEOUT PROCEDURES

- A. Comply with procedures stated in General Conditions of Contract for issuance of Certificate of Substantial Completion.
- B. When CONTRACTOR considers Work has reached final completion, submit written certification that Contract Documents have been reviewed, Work has been inspected, and that Work is complete in accordance with Contract Documents and ready for ENGINEER'S inspection.
- C. In addition to submittals required by conditions of Agreement, provide submittals required by governing authorities, and submit final statement of accounting giving total adjusted Contract Price, previous payments, and sum remaining due.
- D. ENGINEER will issue final change order reflecting approved adjustments to Contract Price not previously made by Change Order.

1.19 FINAL CLEANING

- A. Execute prior to final inspection.
- B. Clean site; sweep paved areas, rake clean other surfaces.
- C. Remove waste and surplus materials, rubbish, and construction facilities from Project and from site.

1.20 PROJECT RECORD DOCUMENTS

- A. Store documents separate from those used for construction.
- B. Keep documents current; do not permanently conceal any Work until required information has been recorded.
- C. At Contract closeout, submit documents with transmittal letter containing date, Project title, CONTRACTOR'S name and address, list of documents, and signature of CONTRACTOR.

END OF SECTION

SUBMITTALS

PART 1 GENERAL

1.01 PROCEDURES

- A. Deliver submittals to:
- Clapsaddle-Garber Associates, Inc.
739 Park Avenue
Ackley, IA 50601
(or)
Electronically via email (to the Engineer listed in the Instructions to Bidder)
- B. Transmit each item under Shop Drawing Transmittal Form, bound herein. Identify Project, CONTRACTOR, Subcontractor, major supplier; identify pertinent Drawing sheet and detail number, and Specification section number, as appropriate. Identify deviations from Contract Documents. Provide space for CONTRACTOR and ENGINEER review stamps on each item.
- C. Submit initial progress schedules and schedule of values in duplicate within 15 days after award of contract. After review by ENGINEER revise and resubmit as required. Submit revised schedules with each Application for Payment, reflecting changes since previous submittal.
- D. Comply with progress schedule for submittals related to Work progress. Coordinate submittal of related items.
- E. Notify ENGINEER in writing, at time of submission, of any deviations in submittals from requirements of Contract Documents. Any such deviations permitted by ENGINEER will require modifications of Contract Documents.
- F. Begin no fabrication or Work which requires submittals until return of submittals by ENGINEER with ENGINEER stamp, as either "Reviewed" or "Reviewed as Noted."
- G. After ENGINEER review of submittal, revise and resubmit as required, identifying changes made since previous submittal.
- H. Distribute reproductions of Shop Drawings which carry ENGINEER stamp as either "Reviewed" or "Reviewed as Noted" to:
1. Job site file.
 2. Record documents file.
 3. Subcontractors.
- I. Distribute Samples which carry ENGINEER stamp as either "Reviewed" or "Reviewed as Noted" as directed by ENGINEER.

1.02 CONSTRUCTION PROGRESS SCHEDULES

- A. Submit horizontal bar chart with separate bar for each major trade or operation, identifying first work day of each week.

- B. Show complete sequence of construction by activity, identifying work of separate stages and other logically grouped activities. Show projected percentage of completion for each item of Work as of time of each progress Application for Payment.
- C. Show submittal dates required for Shop Drawings, Product Data, and Samples, and Product delivery dates, including those furnished by OWNER and those under Allowances.

1.03 SCHEDULE OF VALUES

- A. Submit typed schedule on 8 ½" x 11" paper; CONTRACTOR's standard form or media-driven printout will be considered on request.
- B. Format: Table of Contents of this Project Manual. Identify each line item with number and title of the major Specifications sections.
- C. Include in each line item a directly proportional amount of CONTRACTOR's overhead and profit.
- D. Revise schedule to list change orders, for each application for payment.

1.04 SAFETY PROCEDURES MANUAL

- A. CONTRACTOR shall prepare and submit to OWNER safety procedures manual defining CONTRACTOR's safety program for work on site. Manual shall include:
 - 1. Safety responsibilities of CONTRACTOR's personnel.
 - 2. Description of CONTRACTOR's safety program.
 - 3. Requirements of use of personal protective equipment.
 - 4. General safety-related rules of conduct.
 - 5. Fire prevention measures.
 - 6. Accident reporting procedures.
 - 7. Procedures for hot work (welding, cutting, etc.), overhead work, and work in enclosed, confined spaces (tank, boiler, etc.).

1.05 SHOP DRAWINGS

- A. Shop Drawings shall be presented in clear and thorough manner, complete with respect to dimensions, design criteria, materials of construction, and like information to enable ENGINEER to review information as required. Details shall be identified by reference to sheet and detail shown on Drawings.
- B. Minimum sheet size 8 ½" x 11"
- C. Make submittals to ENGINEER promptly in accordance with approved schedule, and in such sequence as to cause no delay in Work on in work of any other contractor.
- D. Shop Drawings:
 - 1. Submit one opaque reproducible copy of each Shop Drawing.

2. Shop Drawings not larger than 11" x 17", copies of Drawing submitted shall be black line on white background. Electronic submittals will not be accepted.
 3. ENGINEER will reproduce additional copies of Shop Drawings as required for distribution.
 4. ENGINEER will scan Shop Drawings. All Shop Drawings shall be suitable for scanning to PDF. Shop Drawings submitted which are not suitable for scanning will not be reviewed.
 5. If CONTRACTOR will not grant permission for ENGINEER to reproduce Shop Drawings, CONTRACTOR shall submit 5 copies of each Shop Drawing.
 6. For Shop Drawings larger than 11" x 17", printed catalog information or brochures, or other multiple page documents, submit 5 copies of each Shop Drawing.
- E. Reproducible copies of Shop Drawings, if request herein:
1. Submit PDF, or equal, reproducible electronic file. Vellum, sepias, mylar or other nonpermanent reproducible prints are not acceptable.
 2. Reproducible copies of Shop Drawings shall show "as built" conditions of equipment and shall show field modifications required during installation.
 3. CONTRACTOR will provide marked-up print of application Shop Drawings showing field modifications made during installation, within 7 days after it has sufficient information to prepare same.
- F. Submittals shall contain:
1. Date of submission and dates of any previous submissions.
 2. Project title and number.
 3. Contract identification.
 4. Names of:
 - A. CONTRACTOR.
 - B. Supplier.
 - C. Manufacturer.
 5. Identification of product, with Specification section number.
 6. Field dimensions, clearly identified as such.
 7. Relation to adjacent or critical features of Work or materials.
 8. Applicable standards, such as ASTM or Federal Specification numbers.
 9. Identification of deviations from Contract Documents.
 10. Identification of revisions on resubmittals.
 11. An 8" x 3" blank space for CONTRACTOR and ENGINEER stamps.
 12. Indication of CONTRACTOR's approval, initialed or signed, with wording substantially as follows:

"CONTRACTOR represents to OWNER and ENGINEER that CONTRACTOR has either determined and verified all quantities, dimensions, field construction criteria, materials, catalog numbers, and similar data, or assumes full responsibility for doing so and has reviewed or coordinated each Shop Drawing Sample with requirements of Work and Contract Documents."
 13. Shop Drawing Transmittal Form is bound herein.

CONTRACTOR shall reproduce any additional copies required and use in accordance with instructions given with Transmittal Form. CONTRACTOR shall submit 1 copy of Transmittal Form for initial submittals and resubmittals.

- G. Resubmission requirements: Make any corrections or changes in submittals required by ENGINEER and resubmit until stamped as either "Reviewed" or "Reviewed as Noted" by ENGINEER. Indicate any changes which have been made other than those requested by ENGINEER.

1.06 ENGINEER DUTIES

- A. Review required submittals with reasonable promptness and in accord with schedule, only for general conformance to design concept of Project and compliance with information given in Contract Documents. Review shall not extend to means, methods, sequences, techniques, or procedures of construction or to safety precautions or program incident thereto. Review of a separate item as such will not indicate approval of assembly in which item functions.
- B. Affix stamp and initials or signature, and indicate requirements for resubmittal, or review of submittal. ENGINEER's action on submittals is classified as follows:
1. **Reviewed:** Submittal has been reviewed and appears to be in conformance to design concept of Project and Contract Documents. CONTRACTOR may proceed with fabrication of Work detailed in submittal.
 2. **Reviewed As Noted:** Submittal has been reviewed and appears to be in conformance to design concept of Project and Contract Documents, except as noted by ENGINEER. CONTRACTOR may proceed with fabrication of Work detailed in submittal with modifications and corrections as indicated by ENGINEER.
 3. **Resubmit:** Submittal has been reviewed and appears not to be in conformance to design concept of Project or Contract Documents. CONTRACTOR shall not proceed with fabrication of Work detailed in submittal, but instead shall make any corrections required by ENGINEER and resubmit for review.
 4. **Returned:** Submittal has not been reviewed because lacking CONTRACTOR's approval stamp or signature or because otherwise substantially contrary to design concept of the Project or Contract Documents. CONTRACTOR shall not proceed with fabrication of Work as detailed in submittal but instead shall cure defects and resubmit for review, if required by Contract Documents.
- C. Return submittals to CONTRACTOR.
- D. ENGINEER's review of submittals shall not relieve CONTRACTOR from responsibility for any deviations from Contract Documents unless CONTRACTOR has, in writing, called ENGINEER's attention to such deviation at time of submission, and ENGINEER has given written concurrence pursuant to Contract Documents to specific deviation, nor shall any concurrence by ENGINEER relieve CONTRACTOR from responsibility for errors or omissions in submittals.

CONSTRUCTION FACILITIES AND TEMPORARY CONTROLS

PART 1 GENERAL

1.01 WATER

- A. Provide service required for construction operations. Extend branch piping with outlets located so that water is available by use of hoses.

1.02 SANITARY FACILITIES

- A. Provide and maintain required facilities and enclosures.

1.03 BARRIERS

- A. Provide as required to prevent public entry to construction areas and to protect existing facilities and adjacent properties from damage from construction operations.

- B. Provide barricades and covered walkways as required by governing authorities for public rights-of-way and for public access.

- C. Provide barriers around trees and plants designated to remain. Protect against vehicular traffic, stored materials, dumping, chemically injurious materials, and puddling or continuous running water.

1.04 SECURITY

- A. Provide Security program and facilities to protect, Work, and from unauthorized entry, vandalism, and theft. Coordinate with OWNER's security program.

1.05 WATER CONTROL

- A. Grade site to drain. Maintain excavations free of water. Provide and operate pumping equipment.

1.06 CLEANING DURING CONSTRUCTION

- A. Control accumulation of waste materials and rubbish; periodically dispose of off-site.

1.07 FIELD OFFICES AND SHEDS

- A. Office
 - 1. Weathertight, with lightning, electrical outlets, heating, cooling, and ventilating equipment, and equipped with furniture.
 - 2. Provide, in addition, space for Project meetings, with table and chairs to accommodate 6 persons.

- B. Storage sheds, for tools, materials, and equipment: Weathertight, with ventilation for Products requiring controlled conditions, with adequate space for organized storage and access, and lighting for inspection of stored materials.

1.08 REMOVAL

- A. Remove temporary materials, equipment, services, and construction prior to Substantial Completion inspection.

- B. Clean and repair damage caused by installation or use of temporary facilities. Remove Underground installations to a depth of 2'; grade site as indicated.

- C. Restore existing facilities used during construction to specified, or to original, condition.

THIS PAGE LEFT BLANK INTENTIONALLY

SAMPLE FORM OF AGREEMENT BETWEEN OWNER AND CONTRACTOR

Date: _____

THIS AGREEMENT is by and between _____ (“Owner”) and
_____ (“Contractor”).

Owner and Contractor hereby agree as follows:

ARTICLE 1 – WORK

1.01 Contractor shall complete all Work as specified or indicated in the Contract Documents. The Work is generally described as follows:

ARTICLE 2 – THE PROJECT

2.01 The Project for which the Work under the Contract Documents may be the whole or only a part is generally described as follows:

ARTICLE 3 – ENGINEER

3.01 The Project has been designed by, which is to act as Owner’s representative, assume all duties and responsibilities, and have the rights and authority assigned to Engineer in the Contract Documents in connection with the completion of the Work in accordance with the Contract Documents.

ARTICLE 4 – CONTRACT TIMES

4.01 Time of the Essence

A. All time limits for Milestones, if any, Substantial Completion, and completion and readiness for final payment as stated in the Contract Documents are of the essence of the Contract.

4.02 Dates for Substantial Completion and Final Payment

A. The Work will be substantially completed on or before _____, and completed and ready for final payment in accordance with Paragraph 14.07 of the General Conditions on or before _____.

4.03 Liquidated Damages

A. Contractor and Owner recognize that time is of the essence as stated in Paragraph 4.01 above and that Owner will suffer financial loss if the Work is not completed within the times specified in Paragraph 4.02 above, plus any extensions thereof allowed in accordance with Article 12 of the General Conditions. The parties also recognize the delays, expense, and difficulties involved in proving in a legal or arbitration proceeding the actual loss suffered by Owner if the Work is not completed on time. Accordingly, instead of requiring any such proof, Owner and Contractor agree that as liquidated damages for delay (but not as a penalty), Contractor shall pay Owner \$_____ for each day that expires after the time specified in Paragraph 4.02 above for Substantial Completion until the Work is substantially complete. After Substantial Completion, if Contractor shall neglect, refuse, or fail to

complete the remaining Work within the Contract Time or any proper extension thereof granted by Owner, Contractor shall pay Owner \$_____ for each day that expires after the time specified in Paragraph 4.02 above for completion and readiness for final payment until the Work is completed and ready for final payment.

ARTICLE 5 – CONTRACT PRICE

5.01 *Owner shall pay Contractor for completion of the Work in accordance with the Contract Documents an amount in current funds equal to the sum of the amounts determined pursuant to Paragraphs 5.01.A, 5.01.B, and 5.01.C below:*

All specific cash allowances are included in the above price in accordance with Paragraph 11.02 of the General Conditions.

A. For all Unit Price Work, an amount equal to the sum of the established unit price for each separately identified item of Unit Price Work times the actual quantity of that item:

		<u>UNIT PRICE WORK</u>			
<u>Item No.</u>	<u>Description</u>	<u>Unit</u>	<u>Estimated Quantity</u>	<u>Bid Unit Price</u>	<u>Bid Price</u>
Total of all Bid Prices (Unit Price Work)					\$ _____

The Bid prices for Unit Price Work set forth as of the Effective Date of the Agreement are based on estimated quantities. As provided in Paragraph 11.03 of the General Conditions, estimated quantities are not guaranteed, and determinations of actual quantities and classifications are to be made by Engineer as provided in Paragraph 9.07 of the General Conditions.

B. For all Work, at the prices stated in Contractor’s Bid, attached hereto as an exhibit.

ARTICLE 6 – PAYMENT PROCEDURES

6.01 *Submittal and Processing of Payments*

A. Contractor shall submit Applications for Payment in accordance with Article 14 of the General Conditions. Applications for Payment will be processed by Engineer as provided in the General Conditions.

6.02 *Progress Payments; Retainage*

A. Owner shall make progress payments on account of the Contract Price on the basis of Contractor’s Applications for Payment on or about the ____ day of each month during performance of the Work as provided in Paragraph 6.02.A.1 below. All such payments will be measured by the schedule of values established as provided in Paragraph 2.07.A of the General Conditions (and in the case of Unit Price Work based on the number of units completed) or, in the event there is no schedule of values, as provided in the General Requirements.

1. Prior to Substantial Completion, progress payments will be made in an amount equal to the percentage indicated below but, in each case, less the aggregate of payments previously made and

less such amounts as Engineer may determine or Owner may withhold, including but not limited to liquidated damages, in accordance with Paragraph 14.02 of the General Conditions.

- a. _____ percent of Work completed (with the balance being retainage). If the Work has been 50 percent completed as determined by Engineer, and if the character and progress of the Work have been satisfactory to Owner and Engineer, then as long as the character and progress of the Work remain satisfactory to Owner and Engineer, there will be no additional retainage; and
 - b. _____ percent of cost of materials and equipment not incorporated in the Work (with the balance being retainage).
- B. Upon Substantial Completion, Owner shall pay an amount sufficient to increase total payments to Contractor to _____ percent of the Work completed, less such amounts as Engineer shall determine in accordance with Paragraph 14.02.B.5 of the General Conditions and less _____ percent of Engineer's estimate of the value of Work to be completed or corrected as shown on the tentative list of items to be completed or corrected attached to the certificate of Substantial Completion.

6.03 *Final Payment*

- A. Upon final completion and acceptance of the Work in accordance with Paragraph 14.07 of the General Conditions, Owner shall pay the remainder of the Contract Price as recommended by Engineer as provided in said Paragraph 14.07.

ARTICLE 7 – INTEREST

- 7.01 All moneys not paid when due as provided in Article 14 of the General Conditions shall bear interest at the rate of _____ percent per annum.

ARTICLE 8 – CONTRACTOR'S REPRESENTATIONS

- 8.01 In order to induce Owner to enter into this Agreement, Contractor makes the following representations:
- A. Contractor has examined and carefully studied the Contract Documents and the other related data identified in the Bidding Documents.
 - B. Contractor has visited the Site and become familiar with and is satisfied as to the general, local, and Site conditions that may affect cost, progress, and performance of the Work.
 - C. Contractor is familiar with and is satisfied as to all federal, state, and local Laws and Regulations that may affect cost, progress, and performance of the Work.
 - D. Contractor has carefully studied all drawings of physical conditions relating to existing surface or subsurface structures at the Site (except Underground Facilities), if any, that have been identified in Paragraph SC-4.02 of the Supplementary Conditions as containing reliable "technical data," and (2) reports and drawings of Hazardous Environmental Conditions, if any, at the Site that have been identified in Paragraph SC-4.06 of the Supplementary Conditions as containing reliable "technical data."
 - E. Contractor has considered the information known to Contractor; information commonly known to contractors doing business in the locality of the Site; information and observations obtained from visits to the Site; the Contract Documents; and the Site-related reports and drawings identified in the Contract

Documents, with respect to the effect of such information, observations, and documents on (1) the cost, progress, and performance of the Work; (2) the means, methods, techniques, sequences, and procedures of construction to be employed by Contractor, including any specific means, methods, techniques, sequences, and procedures of construction expressly required by the Contract Documents; and (3) Contractor's safety precautions and programs.

- F. Based on the information and observations referred to in Paragraph 8.01.E above, Contractor does not consider that further examinations, investigations, explorations, tests, studies, or data are necessary for the performance of the Work at the Contract Price, within the Contract Times, and in accordance with the other terms and conditions of the Contract Documents.
- G. Contractor is aware of the general nature of work to be performed by Owner and others at the Site that relates to the Work as indicated in the Contract Documents.
- H. Contractor has given Engineer written notice of all conflicts, errors, ambiguities, or discrepancies that Contractor has discovered in the Contract Documents, and the written resolution thereof by Engineer is acceptable to Contractor.
- I. The Contract Documents are generally sufficient to indicate and convey understanding of all terms and conditions for performance and furnishing of the Work.

ARTICLE 9 – CONTRACT DOCUMENTS

9.01 *Contents*

- A. The Contract Documents consist of the following:
 - 1. This Agreement (pages 1 to __, inclusive).
 - 2. Performance bond (pages ____ to ____, inclusive).
 - 3. Payment bond (pages ____ to ____, inclusive).
 - 4. General Conditions (pages ____ to ____, inclusive).
 - 5. Supplementary Conditions (pages ____ to ____, inclusive).
 - 6. Specifications as listed in the table of contents of the Project Manual.
 - 7. Drawings consisting of ____ sheets.
 - 8. Addenda (numbers ____ to ____, inclusive).
 - 9. Exhibits to this Agreement (enumerated as follows):
 - a. Contractor's Bid (pages ____ to ____, inclusive).
 - b. Documentation submitted by Contractor prior to Notice of Award (pages ____ to ____, inclusive).

10. The following which may be delivered or issued on or after the Effective Date of the Agreement and are not attached hereto:
 - a. Notice to Proceed (pages _____ to _____, inclusive).
 - b. Work Change Directives.
 - c. Change Orders.
- B. The documents listed in Paragraph 9.01.A are attached to this Agreement (except as expressly noted otherwise above).
- C. There are no Contract Documents other than those listed above in this Article 9.
- D. The Contract Documents may only be amended, modified, or supplemented as provided in Paragraph 3.04 of the General Conditions.

ARTICLE 10 – MISCELLANEOUS

10.01 *Terms*

- A. Terms used in this Agreement will have the meanings stated in the General Conditions and the Supplementary Conditions.

10.02 *Assignment of Contract*

- A. No assignment by a party hereto of any rights under or interests in the Contract will be binding on another party hereto without the written consent of the party sought to be bound; and, specifically but without limitation, moneys that may become due and moneys that are due may not be assigned without such consent (except to the extent that the effect of this restriction may be limited by law), and unless specifically stated to the contrary in any written consent to an assignment, no assignment will release or discharge the assignor from any duty or responsibility under the Contract Documents.

10.03 *Successors and Assigns*

- A. Owner and Contractor each binds itself, its partners, successors, assigns, and legal representatives to the other party hereto, its partners, successors, assigns, and legal representatives in respect to all covenants, agreements, and obligations contained in the Contract Documents.

10.04 *Severability*

- A. Any provision or part of the Contract Documents held to be void or unenforceable under any Law or Regulation shall be deemed stricken, and all remaining provisions shall continue to be valid and binding upon Owner and Contractor, who agree that the Contract Documents shall be reformed to replace such stricken provision or part thereof with a valid and enforceable provision that comes as close as possible to expressing the intention of the stricken provision.

10.05 *Contractor's Certifications*

- A. Contractor certifies that it has not engaged in corrupt, fraudulent, collusive, or coercive practices in competing for or in executing the Contract. For the purposes of this Paragraph 10.05:

1. “corrupt practice” means the offering, giving, receiving, or soliciting of any thing of value likely to influence the action of a public official in the bidding process or in the Contract execution;
2. “fraudulent practice” means an intentional misrepresentation of facts made (a) to influence the bidding process or the execution of the Contract to the detriment of Owner, (b) to establish Bid or Contract prices at artificial non-competitive levels, or (c) to deprive Owner of the benefits of free and open competition;
3. “collusive practice” means a scheme or arrangement between two or more Bidders, with or without the knowledge of Owner, a purpose of which is to establish Bid prices at artificial, non-competitive levels; and
4. “coercive practice” means harming or threatening to harm, directly or indirectly, persons or their property to influence their participation in the bidding process or affect the execution of the Contract.

IN WITNESS WHEREOF, Owner and Contractor have signed this Agreement. Counterparts have been delivered to Owner and Contractor. All portions of the Contract Documents have been signed or have been identified by Owner and Contractor or on their behalf.

This Agreement will be effective on _____ (which is the Effective Date of the Agreement).

OWNER:

CONTRACTOR

By: _____

By: _____

Title: _____

Title: _____

(If Contractor is a corporation, a partnership, or a joint venture, attach evidence of authority to sign.)

Attest: _____

Attest: _____

Title: _____

Title: _____

Address for giving notices:

Address for giving notices:

License No.: _____

(If Owner is a corporation, attach evidence of authority to sign. If Owner is a public body, attach evidence of authority to sign and resolution or other documents authorizing execution of this Agreement.)

Agent for service of process:

BID BOND

Any singular reference to Bidder, Surety, Owner or other party shall be considered plural where applicable.

BIDDER (*Name and Address*):

SURETY (*Name and Address of Principal Place of Business*):

OWNER (*Name and Address*):

BID

Bid Due Date:

Description (*Project Name and Include Location*):

BOND

Bond Number:

Date (*Not earlier than Bid due date*):

Penal sum _____ \$ _____
(Words) (Figures)

Surety and Bidder, intending to be legally bound hereby, subject to the terms set forth below, do each cause this Bid Bond to be duly executed by an authorized officer, agent, or representative.

BIDDER

SURETY

Bidder's Name and Corporate Seal (Seal)

Surety's Name and Corporate Seal (Seal)

By: _____
Signature

By: _____
Signature (Attach Power of Attorney)

Print Name

Print Name

Title

Title

Attest: _____
Signature

Attest: _____
Signature

Title

Title

1. Bidder and Surety, jointly and severally, bind themselves, their heirs, executors, administrators, successors, and assigns to pay to Owner upon default of Bidder the penal sum set forth on the face of this Bond. Payment of the penal sum is the extent of Bidder's and Surety's liability. Recovery of such penal sum under the terms of this Bond shall be Owner's sole and exclusive remedy upon default of Bidder.
2. Default of Bidder shall occur upon the failure of Bidder to deliver within the time required by the Bidding Documents (or any extension thereof agreed to in writing by Owner) the executed Agreement required by the Bidding Documents and any performance and payment bonds required by the Bidding Documents.
3. This obligation shall be null and void if:
 - 3.1 Owner accepts Bidder's Bid and Bidder delivers within the time required by the Bidding Documents (or any extension thereof agreed to in writing by Owner) the executed Agreement required by the Bidding Documents and any performance and payment bonds required by the Bidding Documents, or
 - 3.2 All Bids are rejected by Owner, or
 - 3.3 Owner fails to issue a Notice of Award to Bidder within the time specified in the Bidding Documents (or any extension thereof agreed to in writing by Bidder and, if applicable, consented to by Surety when required by Paragraph 5 hereof).
4. Payment under this Bond will be due and payable upon default of Bidder and within 30 calendar days after receipt by Bidder and Surety of written notice of default from Owner, which notice will be given with reasonable promptness, identifying this Bond and the Project and including a statement of the amount due.
5. Surety waives notice of any and all defenses based on or arising out of any time extension to issue Notice of Award agreed to in writing by Owner and Bidder, provided that the total time for issuing Notice of Award including extensions shall not in the aggregate exceed 120 days from Bid due date without Surety's written consent.
6. No suit or action shall be commenced under this Bond prior to 30 calendar days after the notice of default required in Paragraph 4 above is received by Bidder and Surety and in no case later than one year after Bid due date.
7. Any suit or action under this Bond shall be commenced only in a court of competent jurisdiction located in the state in which the Project is located.
8. Notices required hereunder shall be in writing and sent to Bidder and Surety at their respective addresses shown on the face of this Bond. Such notices may be sent by personal delivery, commercial courier, or by United States Registered or Certified Mail, return receipt requested, postage pre-paid, and shall be deemed to be effective upon receipt by the party concerned.
9. Surety shall cause to be attached to this Bond a current and effective Power of Attorney evidencing the authority of the officer, agent, or representative who executed this Bond on behalf of Surety to execute, seal, and deliver such Bond and bind the Surety thereby.
10. This Bond is intended to conform to all applicable statutory requirements. Any applicable requirement of any applicable statute that has been omitted from this Bond shall be deemed to be included herein as if set forth at length. If any provision of this Bond conflicts with any applicable statute, then the provision of said statute shall govern and the remainder of this Bond that is not in conflict therewith shall continue in full force and effect.
11. The term "Bid" as used herein includes a Bid, offer, or proposal as applicable.

PERFORMANCE BOND

Any singular reference to Contractor, Surety, Owner, or other party shall be considered plural where applicable.

CONTRACTOR (*Name and Address*): SURETY (*Name, and Address of Principal Place of Business*):

OWNER (*Name and Address*):

CONTRACT

Effective Date of Agreement:
Amount:
Description (*Name and Location*):

BOND

Bond Number:
Date (*Not earlier than Effective Date of Agreement*):
Amount:
Modifications to this Bond Form:

Surety and Contractor, intending to be legally bound hereby, subject to the terms set forth below, do each cause this Performance Bond to be duly executed by an authorized officer, agent, or representative.

CONTRACTOR AS PRINCIPAL

SURETY

Contractor's Name and Corporate Seal (Seal)

Surety's Name and Corporate Seal (Seal)

By: _____
Signature

By: _____
Signature (Attach Power of Attorney)

Print Name

Print Name

Title

Title

Attest: _____
Signature

Attest: _____
Signature

Title

Title

Note: Provide execution by additional parties, such as joint venturers, if necessary.

Contractor and Surety, jointly and severally, bind themselves, their heirs, executors, administrators, successors, and assigns to Owner for the performance of the Contract, which is incorporated herein by reference.

1. If Contractor performs the Contract, Surety and Contractor have no obligation under this Bond, except to participate in conferences as provided in Paragraph 2.1.
2. If there is no Owner Default, Surety's obligation under this Bond shall arise after:
 - 2.1 Owner has notified Contractor and Surety, at the addresses described in Paragraph 9 below, that Owner is considering declaring a Contractor Default and has requested and attempted to arrange a conference with Contractor and Surety to be held not later than 15 days after receipt of such notice to discuss methods of performing the Contract. If Owner, Contractor, and Surety agree, Contractor shall be allowed a reasonable time to perform the Contract, but such an agreement shall not waive Owner's right, if any, subsequently to declare a Contractor Default; and
 - 2.2 Owner has declared a Contractor Default and formally terminated Contractor's right to complete the Contract. Such Contractor Default shall not be declared earlier than 20 days after Contractor and Surety have received notice as provided in Paragraph 2.1; and
 - 2.3 Owner has agreed to pay the Balance of the Contract Price to:
 1. Surety in accordance with the terms of the Contract; or
 2. Another contractor selected pursuant to Paragraph 3.3 to perform the Contract.
3. When Owner has satisfied the conditions of Paragraph 2, Surety shall promptly, and at Surety's expense, take one of the following actions:
 - 3.1 Arrange for Contractor, with consent of Owner, to perform and complete the Contract; or
 - 3.2 Undertake to perform and complete the Contract itself, through its agents or through independent contractors; or
 - 3.3 Obtain bids or negotiated proposals from qualified contractors acceptable to Owner for a contract for performance and completion of the Contract, arrange for a contract to be prepared for execution by Owner and contractor selected with Owner's concurrence, to be secured with performance and payment bonds executed by a qualified surety equivalent to the bonds issued on the Contract, and pay to Owner the amount of damages as described in Paragraph 5 in excess of the Balance of the Contract Price incurred by Owner resulting from Contractor Default; or
 - 3.4 Waive its right to perform and complete, arrange for completion, or obtain a new contractor, and with reasonable promptness under the circumstances:
 1. After investigation, determine the amount for which it may be liable to Owner and, as soon as practicable after the amount is determined, tender payment therefor to Owner; or
 2. Deny liability in whole or in part and notify Owner citing reasons therefor.
4. If Surety does not proceed as provided in Paragraph 3 with reasonable promptness, Surety shall be deemed to be in default on this Bond 15 days after receipt of an additional written notice from Owner to Surety demanding that Surety perform its obligations under this Bond, and Owner shall be entitled to enforce any remedy available to Owner. If Surety proceeds as provided in Paragraph 3.4, and Owner refuses the payment tendered or Surety has denied liability, in whole or in part, without further notice Owner shall be entitled to enforce any remedy available to Owner.
5. After Owner has terminated Contractor's right to complete the Contract, and if Surety elects to act under Paragraph 3.1, 3.2, or 3.3 above, then the responsibilities of Surety to Owner shall not be greater than those of Contractor under the Contract, and the responsibilities of Owner to Surety shall not be greater than those of Owner under the Contract. To the limit of the amount of this Bond, but subject to commitment by Owner of the Balance of the Contract Price to mitigation of costs and damages on the Contract, Surety is obligated without duplication for:

- 5.1 The responsibilities of Contractor for correction of defective Work and completion of the Contract;
- 5.2 Additional legal, design professional, and delay costs resulting from Contractor's Default, and resulting from the actions of or failure to act of Surety under Paragraph 3; and
- 5.3 Liquidated damages, or if no liquidated damages are specified in the Contract, actual damages caused by delayed performance or non-performance of Contractor.

6. Surety shall not be liable to Owner or others for obligations of Contractor that are unrelated to the Contract, and the Balance of the Contract Price shall not be reduced or set off on account of any such unrelated obligations. No right of action shall accrue on this Bond to any person or entity other than Owner or its heirs, executors, administrators, or successors.

7. Surety hereby waives notice of any change, including changes of time, to Contract or to related subcontracts, purchase orders, and other obligations.

8. Any proceeding, legal or equitable, under this Bond may be instituted in any court of competent jurisdiction in the location in which the Work or part of the Work is located, and shall be instituted within two years after Contractor Default or within two years after Contractor ceased working or within two years after Surety refuses or fails to perform its obligations under this Bond, whichever occurs first. If the provisions of this paragraph are void or prohibited by law, the minimum period of limitation available to sureties as a defense in the jurisdiction of the suit shall be applicable.

9. Notice to Surety, Owner, or Contractor shall be mailed or delivered to the address shown on the signature page.

10. When this Bond has been furnished to comply with a statutory requirement in the location where the Contract was to be performed, any provision in this Bond conflicting with said statutory requirement shall be deemed deleted herefrom and provisions conforming to such statutory requirement shall be deemed incorporated herein. The intent is that this Bond shall be construed as a statutory bond and not as a common law bond.

11. Definitions.

- 11.1 Balance of the Contract Price: The total amount payable by Owner to Contractor under the Contract after all proper adjustments have been made, including allowance to Contractor of any amounts received or to be received by Owner in settlement of insurance or other Claims for damages to which Contractor is entitled, reduced by all valid and proper payments made to or on behalf of Contractor under the Contract.
- 11.2 Contract: The agreement between Owner and Contractor identified on the signature page, including all Contract Documents and changes thereto.
- 11.3 Contractor Default: Failure of Contractor, which has neither been remedied nor waived, to perform or otherwise to comply with the terms of the Contract.
- 11.4 Owner Default: Failure of Owner, which has neither been remedied nor waived, to pay Contractor as required by the Contract or to perform and complete or otherwise comply with the other terms thereof.

THIS PAGE LEFT BLANK INTENTIONALLY

PAYMENT BOND

Any singular reference to Contractor, Surety, Owner, or other party shall be considered plural where applicable.

CONTRACTOR (*Name and Address*):

SURETY (*Name, and Address of Principal Place of Business*):

OWNER (*Name and Address*):

CONTRACT

Effective Date of Agreement:

Amount:

Description (*Name and Location*):

BOND

Bond Number:

Date (*Not earlier than Effective Date of Agreement*):

Amount:

Modifications to this Bond Form:

Surety and Contractor, intending to be legally bound hereby, subject to the terms set forth below, do each cause this Payment Bond to be duly executed by an authorized officer, agent, or representative.

CONTRACTOR AS PRINCIPAL

SURETY

(Seal)
Contractor's Name and Corporate Seal

(Seal)
Surety's Name and Corporate Seal

By: _____
Signature

By: _____
Signature (Attach Power of Attorney)

Print Name

Print Name

Title

Title

Attest: _____
Signature

Attest: _____
Signature

Title

Title

Note: Provide execution by additional parties, such as joint venturers, if necessary.

1. Contractor and Surety, jointly and severally, bind themselves, their heirs, executors, administrators, successors, and assigns to Owner to pay for labor, materials, and equipment furnished by Claimants for use in the performance of the Contract, which is incorporated herein by reference.
2. With respect to Owner, this obligation shall be null and void if Contractor:
 - 2.1 Promptly makes payment, directly or indirectly, for all sums due Claimants, and
 - 2.2 Defends, indemnifies, and holds harmless Owner from all claims, demands, liens, or suits alleging non-payment by Contractor by any person or entity who furnished labor, materials, or equipment for use in the performance of the Contract, provided Owner has promptly notified Contractor and Surety (at the addresses described in Paragraph 12) of any claims, demands, liens, or suits and tendered defense of such claims, demands, liens, or suits to Contractor and Surety, and provided there is no Owner Default.
3. With respect to Claimants, this obligation shall be null and void if Contractor promptly makes payment, directly or indirectly, for all sums due.
4. Surety shall have no obligation to Claimants under this Bond until:
 - 4.1 Claimants who are employed by or have a direct contract with Contractor have given notice to Surety (at the address described in Paragraph 12) and sent a copy, or notice thereof, to Owner, stating that a claim is being made under this Bond and, with substantial accuracy, the amount of the claim.
 - 4.2 Claimants who do not have a direct contract with Contractor:
 1. Have furnished written notice to Contractor and sent a copy, or notice thereof, to Owner, within 90 days after having last performed labor or last furnished materials or equipment included in the claim stating, with substantial accuracy, the amount of the claim and the name of the party to whom the materials or equipment were furnished or supplied, or for whom the labor was done or performed; and
 2. Have either received a rejection in whole or in part from Contractor, or not received within 30 days of furnishing the above notice any communication from Contractor by which Contractor had indicated the claim will be paid directly or indirectly; and
 3. Not having been paid within the above 30 days, have sent a written notice to Surety (at the address described in Paragraph 12) and sent a copy, or notice thereof, to Owner, stating that a claim is being made under this Bond and enclosing a copy of the previous written notice furnished to Contractor.
5. If a notice by a Claimant required by Paragraph 4 is provided by Owner to Contractor or to Surety, that is sufficient compliance.
6. Reserved.
7. Surety's total obligation shall not exceed the amount of this Bond, and the amount of this Bond shall be credited for any payments made in good faith by Surety.
8. Amounts owed by Owner to Contractor under the Contract shall be used for the performance of the Contract and to satisfy claims, if any, under any performance bond. By Contractor furnishing and Owner accepting this Bond, they agree that all funds earned by Contractor in the performance of the Contract are dedicated to satisfy obligations of Contractor and Surety under this Bond, subject to Owner's priority to use the funds for the completion of the Work.
9. Surety shall not be liable to Owner, Claimants, or others for obligations of Contractor that are unrelated to the Contract. Owner shall not be liable for payment of any costs or expenses of any Claimant under this Bond, and shall have under this Bond no obligations to make payments to, give notices on behalf of, or otherwise have obligations to Claimants under this Bond.

10. Surety hereby waives notice of any change, including changes of time, to the Contract or to related subcontracts, purchase orders, and other obligations.

11. No suit or action shall be commenced by a Claimant under this Bond other than in a court of competent jurisdiction in the location in which the Work or part of the Work is located or after the expiration of one year from the date (1) on which the Claimant gave the notice required by Paragraph 4.1 or Paragraph 4.2.3, or (2) on which the last labor or service was performed by anyone or the last materials or equipment were furnished by anyone under the Contract, whichever of (1) or (2) first occurs. If the provisions of this paragraph are void or prohibited by law, the minimum period of limitation available to sureties as a defense in the jurisdiction of the suit shall be applicable.

12. Notice to Surety, Owner, or Contractor shall be mailed or delivered to the addresses shown on the signature page. Actual receipt of notice by Surety, Owner, or Contractor, however accomplished, shall be sufficient compliance as of the date received at the address shown on the signature page.

13. When this Bond has been furnished to comply with a statutory requirement in the location where the Contract was to be performed, any provision in this Bond conflicting with said statutory requirement shall be deemed deleted herefrom and provisions conforming to such statutory requirement shall be deemed incorporated herein. The intent is that this Bond shall be construed as a statutory Bond and not as a common law bond.

14. Upon request of any person or entity appearing to be a potential beneficiary of this Bond, Contractor shall promptly furnish a copy of this Bond or shall permit a copy to be made.

15. Definitions

15.1 Claimant: An individual or entity having a direct contract with Contractor, or with a first-tier subcontractor of Contractor, to furnish labor, materials, or equipment for use in the performance of the Contract. The intent of this Bond shall be to include without limitation in the terms “labor, materials or equipment” that part of water, gas, power, light, heat, oil, gasoline, telephone service, or rental equipment used in the Contract, architectural and engineering services required for performance of the Work of Contractor and Contractor’s subcontractors, and all other items for which a mechanic’s lien may be asserted in the jurisdiction where the labor, materials, or equipment were furnished.

15.2 Contract: The agreement between Owner and Contractor identified on the signature page, including all Contract Documents and changes thereto.

15.3 Owner Default: Failure of Owner, which has neither been remedied nor waived, to pay Contractor as required by the Contract, or to perform and complete or otherwise comply with the other terms thereof.

FOR INFORMATION ONLY – *(Name, Address, and Telephone)*

Surety Agency or Broker:

Owner’s Representative *(Engineer or other)*:

Contractor's Qualification Statement

SUBMITTED TO: Clapsaddle-Garber Associates, Inc.
739 Park Avenue
Ackley, Iowa 50601

SUBMITTED BY: _____

NAME OF PROJECT: _____

TYPE OF WORK Concrete Underground Utilities
 Asphalt Drainage
 Grading/Dirtwork Sewer Inspection/Televising
 Jack & Boring Other _____

COMPANY INFORMATION:

How many years has your company been in business as a Contractor?

Under what other or former names (and what years) has your company operated?

If your company is a corporation, answer the following:

Date of Incorporation:

State of Incorporation:

President's name:

If your company is a partnership, answer the following:

Date of organization:

Type of partnership:

Name(s) of general partner(s):

If your company is individually owned, answer the following:

Date of organization:

Name of owner:

List of equipment that will be used by your company for this project:

LICENSING

List trade categories to which your company is legally qualified to do business, and indicate registration or license numbers for the State of Iowa:

EXPERIENCE

List the type of work that your company normally performs:

List major construction projects your company has in progress, giving the names of project owners, contract amount, percent complete and scheduled completion. (Attach extra sheets if needed)

State total worth of work in progress and under contract:

List last ten major projects your company has completed in the past five years, stating nature of the project, owner, contract amount, date of completion and percentage of the cost of the work performed with your own forces.

State average annual amount of construction work performed during the last five years:

State name of Project Supervisor:

Experience level of Project Supervisor and Field Crew:

CLAIMS AND SUITS (If you answer yes to any of the below, please attach details)

Has your company ever failed to complete any work it has been awarded?

Are there any judgments, claims, arbitration proceedings or suits pending or outstanding against your company or its officers?

Has your company filed any lawsuits or requested arbitration with regard to construction contracts within the last five years.

Within the last five years has any officer of your company ever been an officer for another company when it failed to complete a construction contract?

REFERENCES

Professional References:

Supplier References:

Bank References:

Surety:

Name of bonding company:

Name and address of the agent:

FINANCING – Statements to be submitted only if contract awarded.

Signature

Name of Company

Dated this ____ day of _____, 20__

THIS PAGE LEFT BLANK INTENTIONALLY

THIS PAGE LEFT BLANK INTENTIONALLY

INSTRUCTIONS

1. Section I will be initiated by the Contractor in the required number of copies.
2. Each Transmittal shall be numbered consecutively. The Transmittal Number typically includes two parts separated by a dash (-). The first part is the specification section number. The second part is a sequential number for the submittals under that spec section. If the Transmittal is a resubmittal, then add a decimal point to the end of the original Transmittal Number and begin numbering the resubmittal packages sequentially after the decimal.
3. The "Item No." for each entry on this form will be the same "Item No." as indicated on ENG FORM 4288-R.
4. Submittals requiring expeditious handling will be submitted on a separate ENG Form 4025-R.
5. Items transmitted on each transmittal form will be from the same specification section. Do not combine submittal information from different specification sections in a single transmittal.
6. If the data submitted are intentionally in variance with the contract requirements, indicate a variation in column h, and enter a statement in the Remarks block describing the detailed reason for the variation.
7. ENG Form 4025-R is self-transmitting - a letter of transmittal is not required.
8. When submittal items are transmitted, indicate the "Submittal Type" (*SD-01 through SD-11*) in column c of Section I.
Submittal types are the following:
SD-01 - Preconstruction SD-02 - Shop Drawings SD-03 - Product Data SD-04 - Samples SD-05 - Design Data SD-06 - Test Reports
SD-07 - Certificates SD-08 - Manufacturer's Instructions SD-09 - Manufacturer's Field Reports SD-10 - O&M Data SD-11 - Closeout
9. For each submittal item, the Contractor will assign Submittal Action Codes in column g of Section I. The U.S. Army Corps of Engineers approving authority will assign Submittal Action Codes in column i of Section I. The Submittal Action Codes are:

A -- Approved as submitted.	F -- Receipt acknowledged.
B -- Approved, except as noted on drawings. Resubmission not required.	X -- Receipt acknowledged, does not comply with contract requirements, as noted.
C -- Approved, except as noted on drawings. Refer to attached comments. Resubmission required.	G -- Other action required (<i>Specify</i>)
D -- Will be returned by separate correspondence.	K -- Government concurs with intermediate design. (<i>For D-B contracts</i>)
E -- Disapproved. Refer to attached comments.	R -- Design submittal is acceptable for release for construction. (<i>For D-B contracts</i>)
10. Approval of items does not relieve the contractor from complying with all the requirements of the contract.

UPPER MAIN TILE DIVERSION DRAINAGE DISTRICT 56 HARDIN COUNTY, IOWA 2021



VICINITY MAP
NOT TO SCALE

WORK AND MATERIALS SHALL BE IN ACCORDANCE WITH
THE IOWA STATEWIDE URBAN STANDARD
SPECIFICATIONS FOR PUBLIC IMPROVEMENTS, 2021
EDITION (SUDAS)

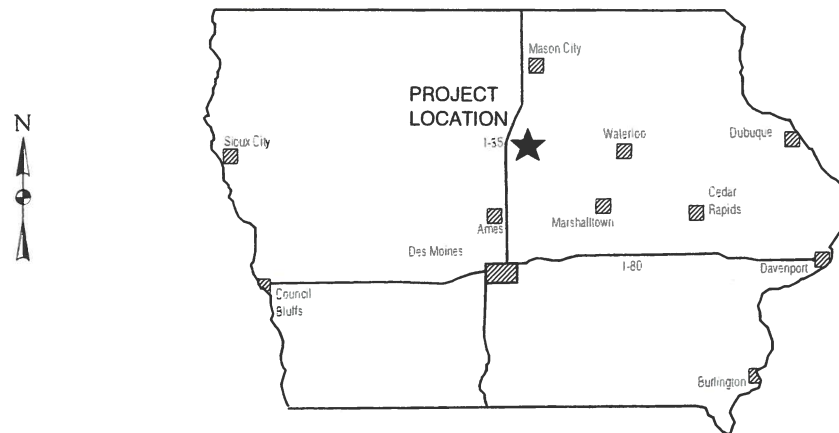

LOCATION MAP



Clapsaddle-Garber Associates, Inc.
739 Park Avenue
Ackley, Iowa 50601
Phone 641-847-3273
www.cgaconsultants.com

INDEX OF SHEETS

SHEET NO.	DESCRIPTION
A.01	TITLE SHEET
A.02	SYMBOLS, LEGEND AND GENERAL INFORMATION
B.01	DETAILS
D.01 - D.03	PLAN & PROFILE

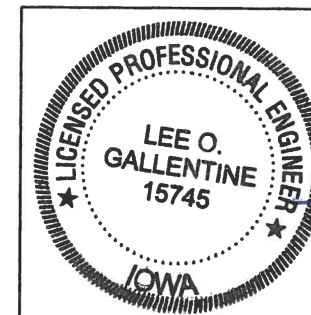

I hereby certify that this engineering document was prepared by me or under my direct personal supervision and that I am a duly licensed Professional Engineer under the laws of the State of Iowa.

Lee O. Gallentine, PE
Signature
Lee O. Gallentine, PE

Iowa License Number 15745
My license renewal date is December 31, 2022

Pages or sheets covered by this seal: As shown on Index

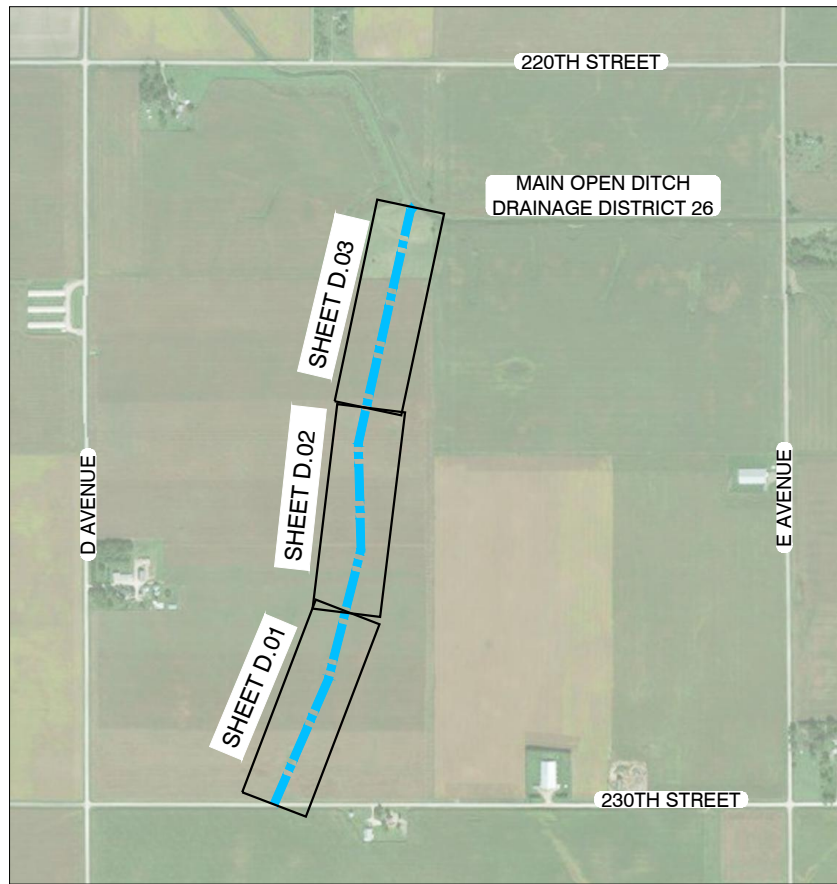

VISUAL INDEX
NOT TO SCALE

NOTES:

1. ALL PIPE LENGTHS SHOWN ARE THROUGH ALL STRUCTURES. HOWEVER, CONTRACTOR SHALL BE PAID ONLY FOR ACTUAL PIPE LENGTH INSTALLED IN COMPLETED SYSTEM.
2. CONTRACTOR SHALL PROTECT ALL TREES (INCLUDING LIMBS) SHOWN IN THE PROJECT PLANS UNLESS NOTED OTHERWISE. ALL TREES SHALL BE PROTECTED FROM DAMAGE TO TRUNKS, BRANCHES AND ROOTS. NO EXCAVATING, FILLING, GRADING, HAUL ROUTES OR MATERIAL STORAGE SHALL BE WITHIN THE DRIP LINE OF THE TREE(S) UNLESS OTHERWISE INDICATED. IF REQUIRED, CONTRACTOR SHALL PROVIDE BRANCH AND ROOT PRUNING REQUIRED FOR THE MEANS AND METHODS PROPOSED FOR THE NEW WORK BY A REGISTERED ARBORIST IN ADVANCE OF CONSTRUCTION. COST SHALL BE INCLUDED IN THE ASSOCIATED NEW WORK ITEM.
3. ONLY VISIBLE UTILITIES ARE PLOTTED ON THESE PLANS. THERE MAY BE SOME, THE EXISTENCE OF WHICH MAY BE KNOWN OR UNKNOWN. THE CONTRACTOR SHALL USE THE CONSTRUCTION PLANS IN CONJUNCTION WITH THE IOWA ONE-CALL SERVICE FOR THE ENTIRE PROJECT PRIOR TO STARTING ANY CONSTRUCTION TO ALLOW REVIEW FOR POSSIBLE UTILITY CONFLICTS. CONTRACTOR SHALL CONTACT ONE-CALL TO OBTAIN UTILITY LOCATES PRIOR TO STARTING CONSTRUCTION. WHERE PROPOSED CONSTRUCTION SHALL CROSS EXISTING UTILITIES, SERVICE, AND TILE LINES, CONTRACTOR SHALL LOCATE AND EXPOSE SAID UTILITIES, SERVICE, AND TILE LINES AT LEAST 24 HOURS PRIOR TO ANY CONSTRUCTION TO ALLOW REVIEW FOR POSSIBLE UTILITY CONFLICTS.
4. ATTENTION IS DIRECTED TO THE FACT THAT THESE PLANS MAY HAVE BEEN REDUCED OR INCREASED IN SIZE BY REPRODUCTION. THIS MUST BE CONSIDERED WHEN OBTAINING SCALED DATA.

BENCHMARKS:

HARDIN COUNTY GPS MONUMENT NO. 8006
2020 SURVEY ELEVATION = 1156.50

HARDIN COUNTY GPS MONUMENT NO. 8007
2020 SURVEY ELEVATION = 1203.31

PLAN SHEET LEGEND

EXISTING	PROPOSED	
		STREET SIGN POST
		SIGN POST
		SHRUBS (BUSHES)
		DECIDUOUS TREE
		EVERGREEN TREE
		GUY ANCHOR
		POWER POLE
		TELEPHONE PEDESTAL
		TELEPHONE BOX
		ELECTRICAL BOX/TRANSFORMER
		ELECTRICAL METER
		LIGHT POLE
		GAS VALVE
		GAS METER
		FIRE HYDRANT
		WATER VALVE
		WATER SHUT-OFF
		MANHOLE
		TILE OUTLET
		BURIED FIBER OPTIC LINE
		OVERHEAD ELECTRICAL LINE
		FENCE
		GAS LINE
		WATERLINE
		SANITARY SEWER LINE
		DRAIN TILE
		STORM SEWER LINE
		PROPERTY LINE
		SECTION/R.O.W. LINE
		CONTOUR LINE
		PROPOSED CONCRETE SURFACE
		EXIST. CONCRETE SURFACE /REMOVAL
		PROPOSED GRAVEL SURFACE
		GRAVEL SURFACE/REMOVAL
		PROPOSED ACC PAVEMENT
		EXIST. ACC PAVEMENT/REMOVAL
		EXIST. SURFACE MILLING/OVERLAY
		EXIST. BRICK/STAMPED CONCRETE

PIPE MATERIAL ABBREVIATIONS

ACP	-	ASPHALT COATED PIPE
AWWA	-	AMERICAN WATER WORKS ASSOCIATION
CMLC	-	CEMENT MORTAR LINED AND COATED
CMP	-	CORRUGATED METAL PIPE
DIP	-	DUCTILE IRON PIPE
ELL	-	ELLIPTICAL
HDPE	-	HIGH DENSITY POLYETHYLENE
PPL	-	POLYPROPYLENE PIPE
PVC	-	POLYVINYL CHLORIDE
RCP	-	REINFORCED CONCRETE PIPE
RCEC	-	REINFORCED CONCRETE ELLIPTICAL PIPE
VCP	-	VITRIFIED CLAY PIPE

ABBREVIATIONS

ADAAG	-	AMERICAN DISABILITIES ACT ACCESSIBILITY GUIDELINES
BM	-	BENCHMARK
BOC	-	BACK OF CURB
CDS	-	CUL DE SAC
CL	-	CENTERLINE
EG	-	EXISTING GROUND
EP	-	EDGE OF PAVEMENT
FG	-	FORM GRADE
FL	-	FLOW LINE
HP	-	HIGH POINT
INV	-	INVERT
LP	-	LOW POINT
MAX	-	MAXIMUM
MIN	-	MINIMUM
MUTCD	-	MANUAL OF UNIFORM TRAFFIC CONTROL DEVICES
PC	-	POINT OF CURVATURE
PCC	-	PORTLAND CEMENT CONCRETE
PRC	-	POINT OF REVERSE CURVATURE
PT	-	POINT OF TANGENCY
R/W	-	RIGHT OF WAY
TOC	-	TOP OF CONCRETE
TYP	-	TYPICAL

NO.	REVISION	BY	DATE	NO.	REVISION	BY	DATE

CGA Clapsaddle-Garber Associates, Inc.
739 Park Avenue
Ackley, Iowa 50801
Ph 641-847-3273
www.cgaconsultants.com

DESIGNED: ZJS DATE: ---
DRAWN: KMN DATE: ---
CHECKED: ZJS DATE: ---
APPROVED: LOG DATE: ---

DRAINAGE DISTRICT 56
HARDIN CO, IOWA

SYMBOLS, LEGENDS, & GENERAL INFORMATION

PROJECT NO. 6830.4
SHEET NO. A.02

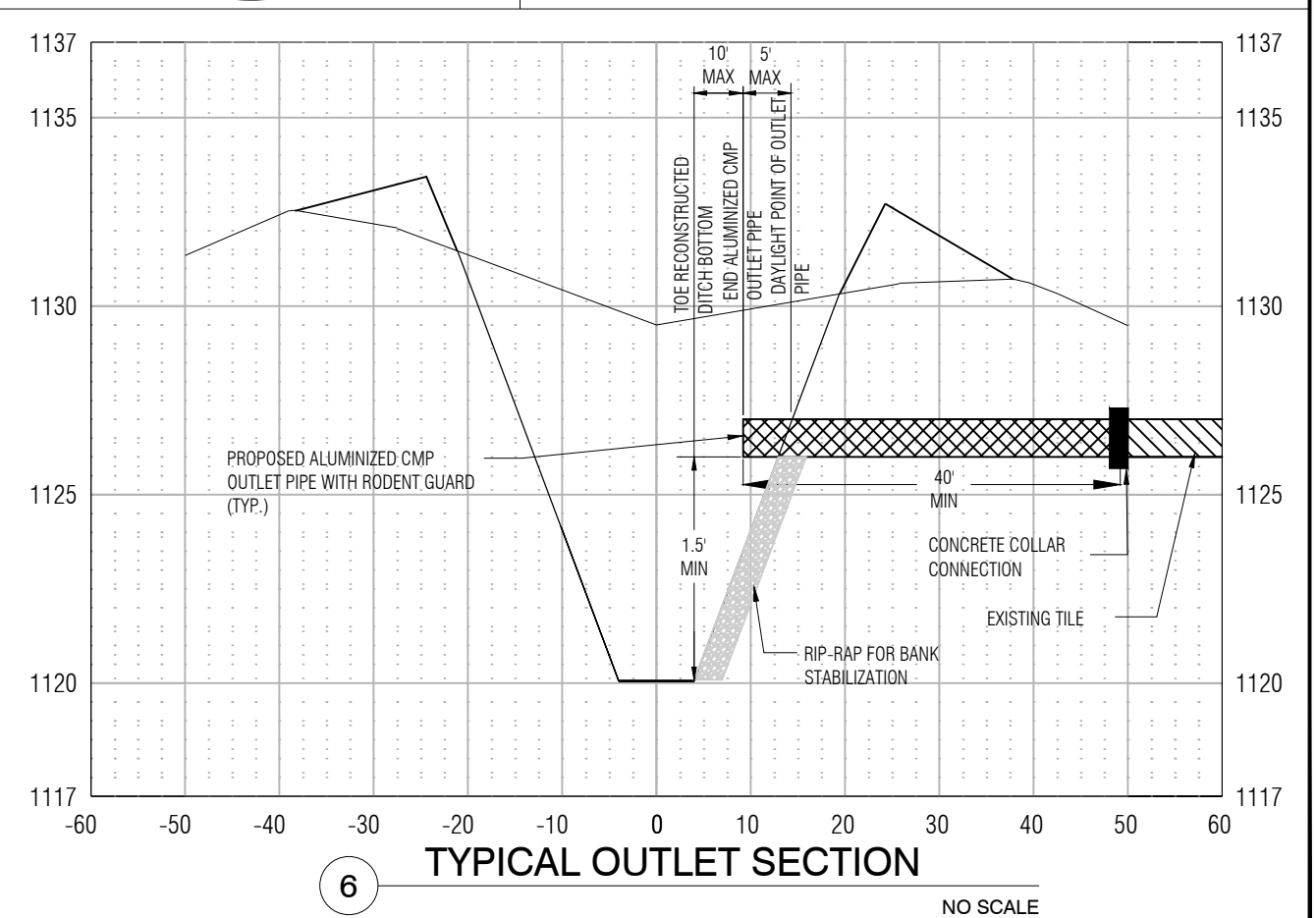
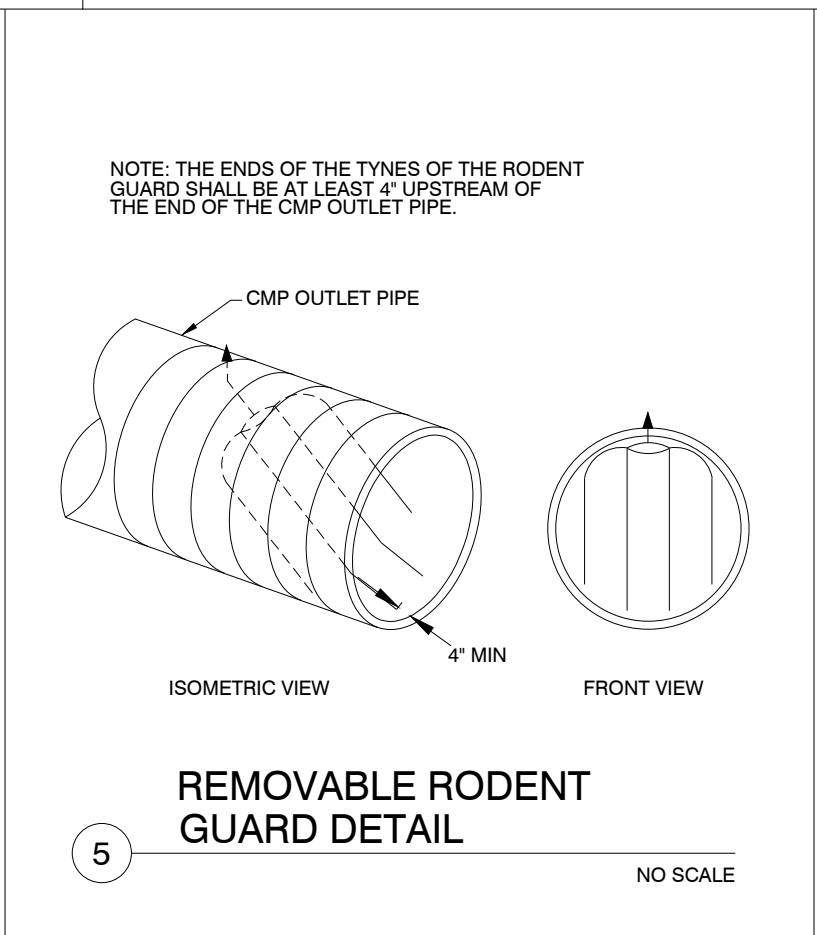
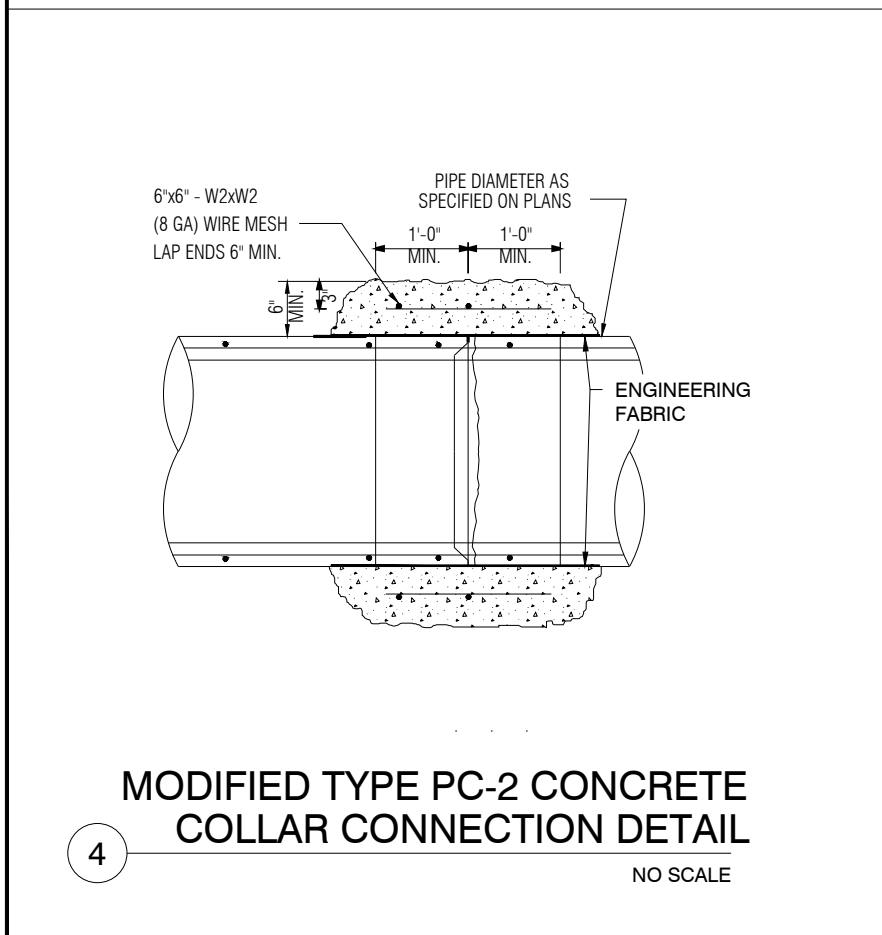
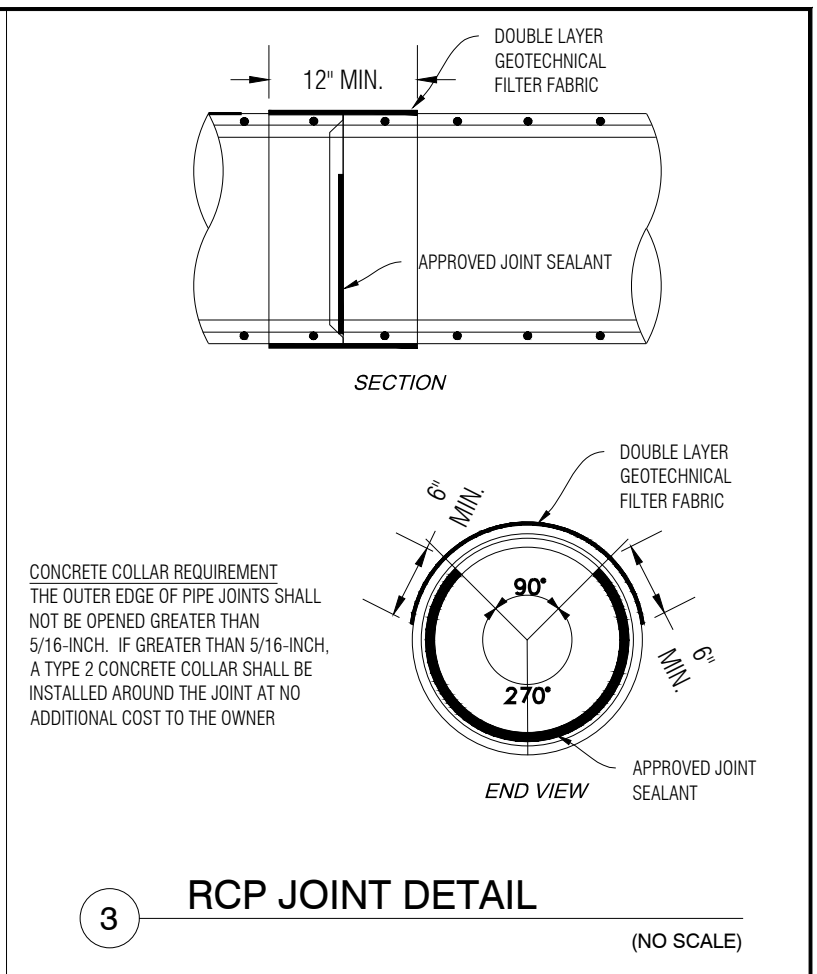
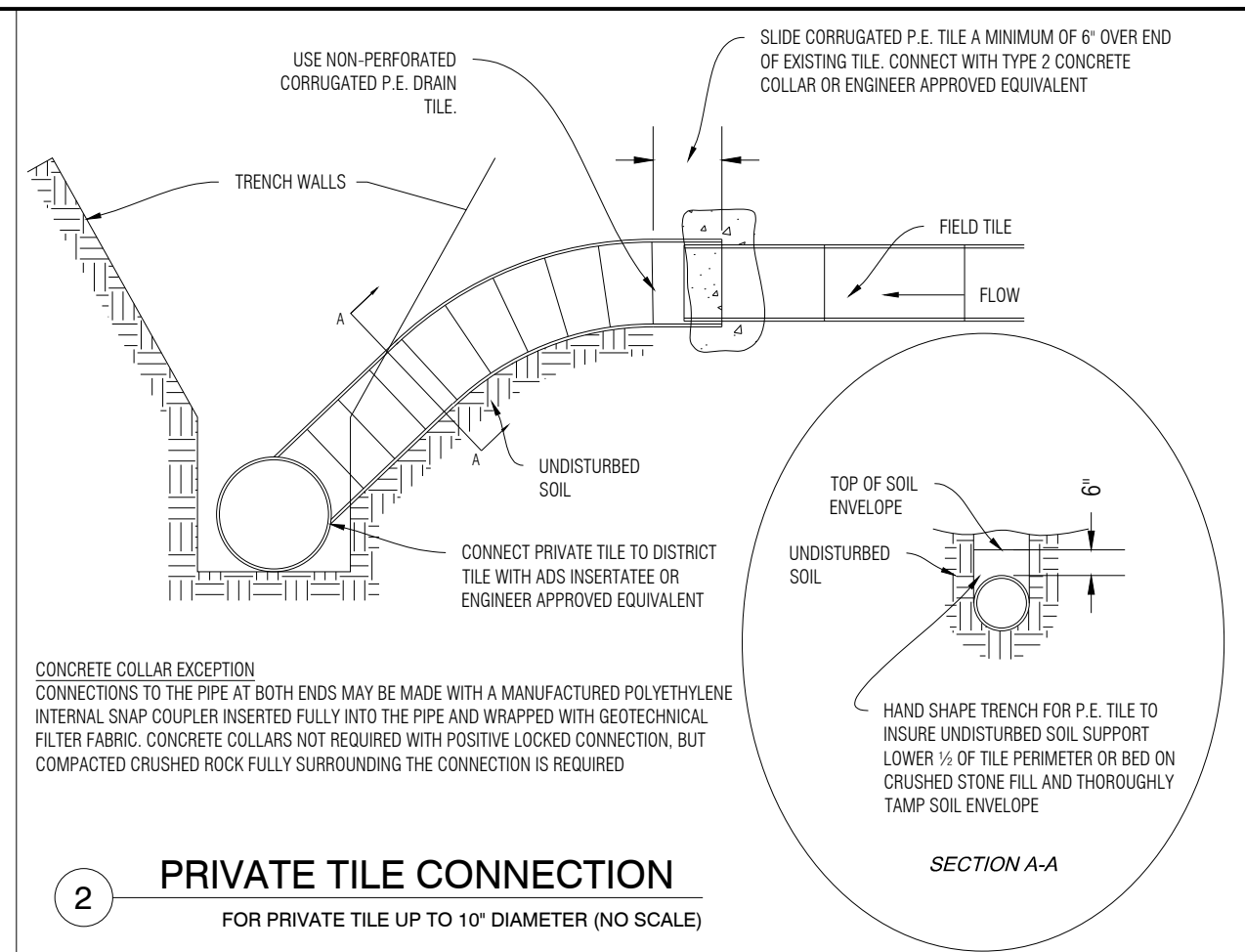
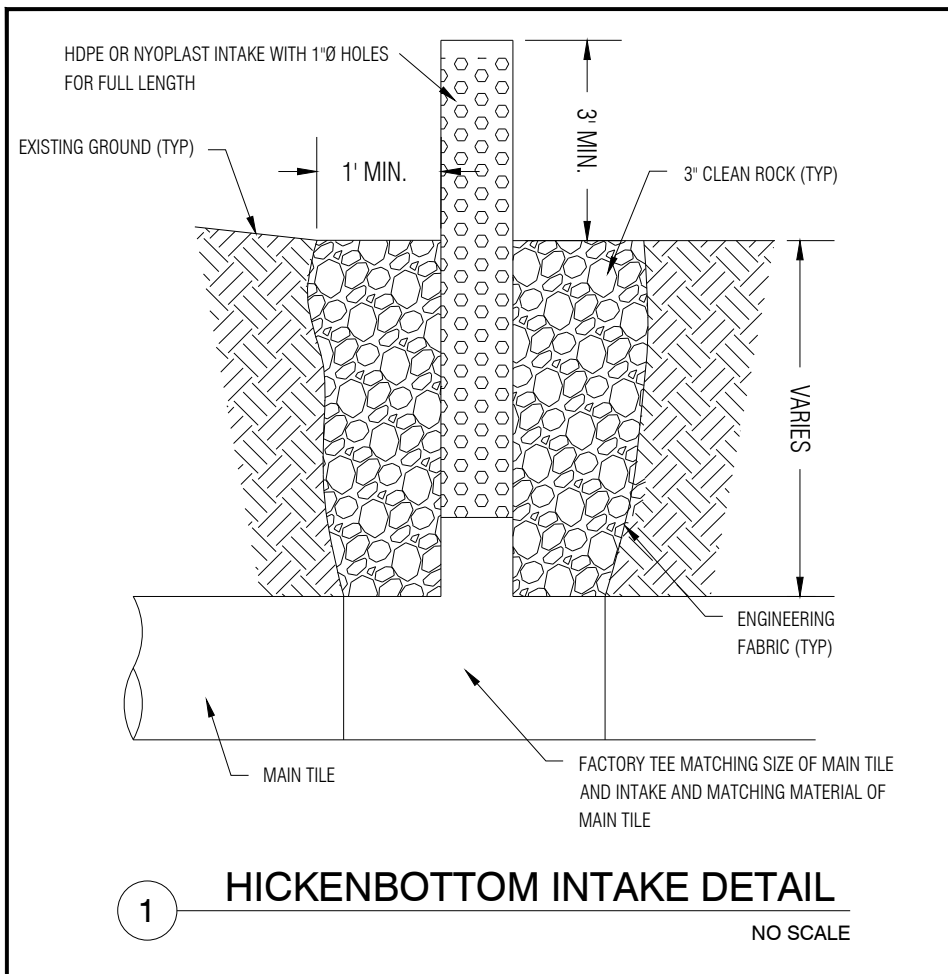

J:\6830_4\DWG\Sheets\6830_4_B_Sheets (Details).dwg - B.01 - 02-19-21 - 10:05am - ZJS43

NO.	REVISION	BY	DATE	NO.	REVISION	BY	DATE

CGA Clapsaddle-Garber Associates, Inc.
739 Park Avenue
Ackley, Iowa 50801
Ph 641-847-3273
www.cgaconsultants.com

DESIGNED: ZJS DATE: ---
DRAWN: KMN DATE: ---
CHECKED: ZJS DATE: ---
APPROVED: LOG DATE: ---

DRAINAGE DISTRICT 56
HARDIN CO, IOWA

DETAILS

PROJECT NO. 6830.4
SHEET NO. B.01

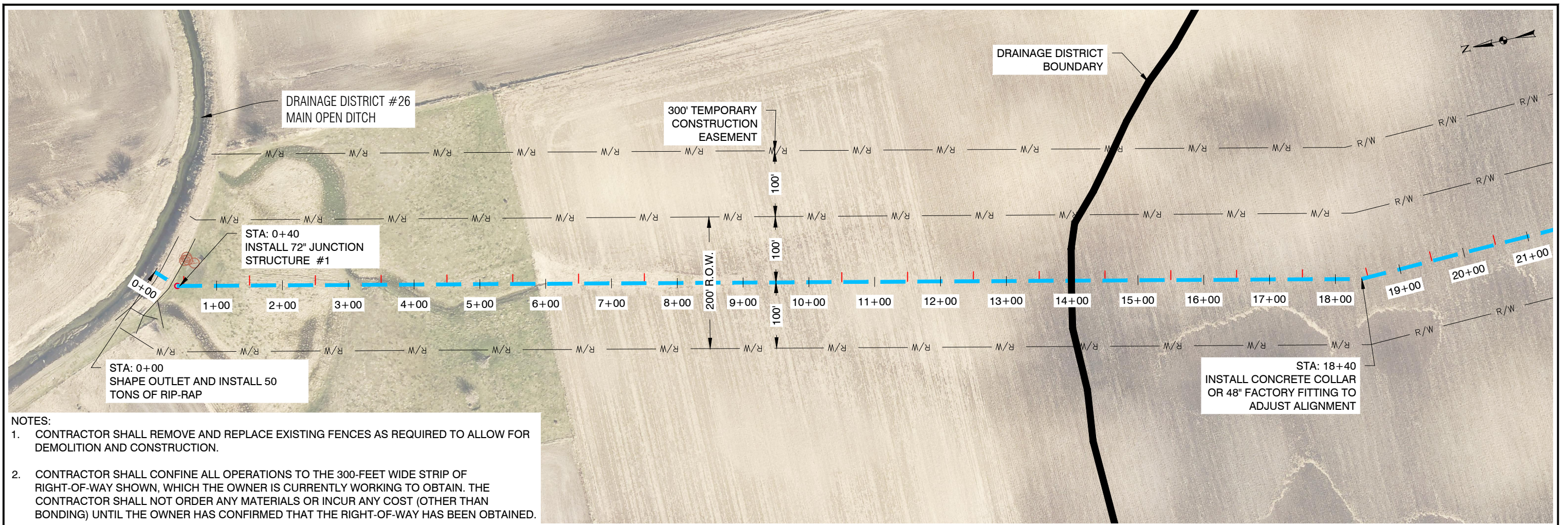

- NOTES:**
- CONTRACTOR SHALL REMOVE AND REPLACE EXISTING FENCES AS REQUIRED TO ALLOW FOR DEMOLITION AND CONSTRUCTION.
 - CONTRACTOR SHALL CONFINE ALL OPERATIONS TO THE 300-FOOT WIDE STRIP OF RIGHT-OF-WAY SHOWN, WHICH THE OWNER IS CURRENTLY WORKING TO OBTAIN. THE CONTRACTOR SHALL NOT ORDER ANY MATERIALS OR INCUR ANY COST (OTHER THAN BONDING) UNTIL THE OWNER HAS CONFIRMED THAT THE RIGHT-OF-WAY HAS BEEN OBTAINED.

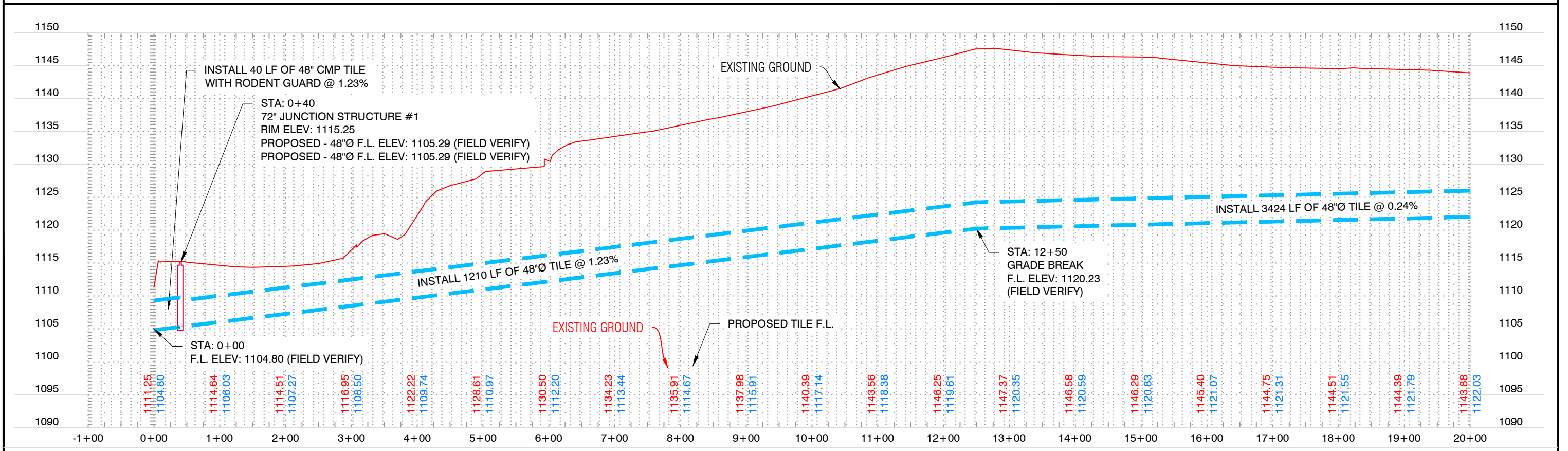

NO.	REVISION	BY	DATE	NO.	REVISION	BY	DATE

1" = 5' VERTICAL SCALE
GRAPHIC SCALE

CGA Clapsaddle-Garber Associates, Inc.
738 Park Avenue
Ackley, Iowa 50801
Ph 641-847-3279
www.cgaconsultants.com

DESIGNED: ZJS DATE: ---
DRAWN: KMN DATE: ---
CHECKED: ZJS DATE: ---
APPROVED: LOG DATE: ---

DRAINAGE DISTRICT 56
HARDIN CO, IOWA

PLAN AN PROFILE

PROJECT NO. 6830.4
SHEET NO. D.01

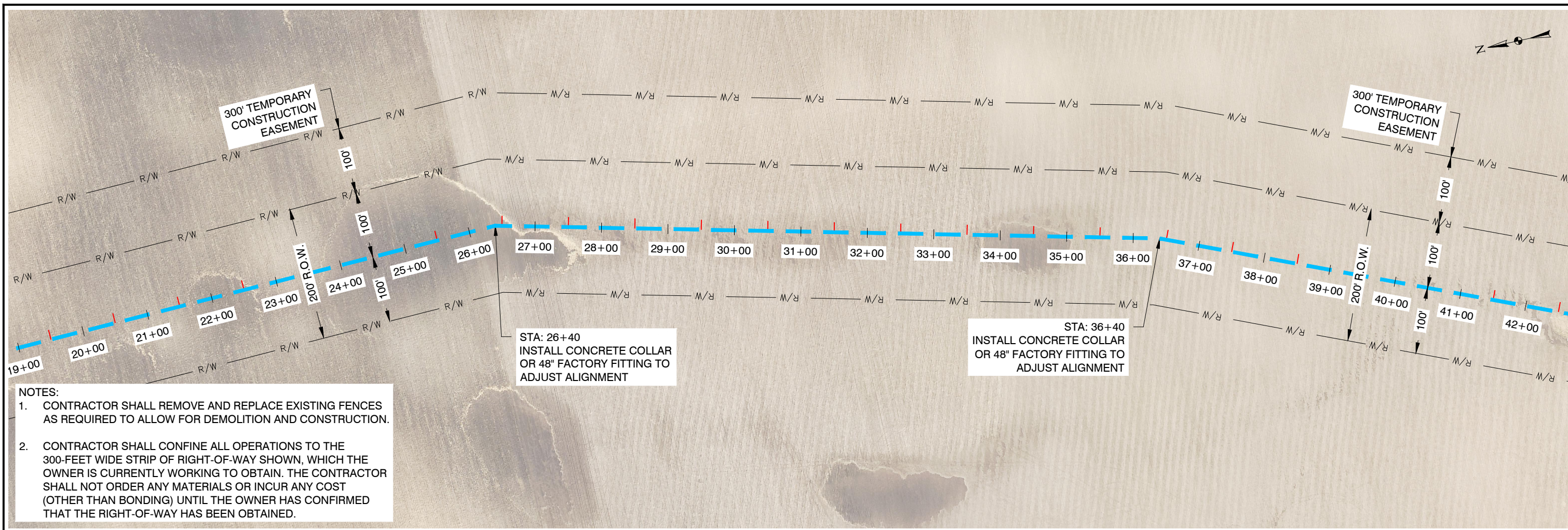

- NOTES:**
1. CONTRACTOR SHALL REMOVE AND REPLACE EXISTING FENCES AS REQUIRED TO ALLOW FOR DEMOLITION AND CONSTRUCTION.
 2. CONTRACTOR SHALL CONFINE ALL OPERATIONS TO THE 300-FOOT WIDE STRIP OF RIGHT-OF-WAY SHOWN, WHICH THE OWNER IS CURRENTLY WORKING TO OBTAIN. THE CONTRACTOR SHALL NOT ORDER ANY MATERIALS OR INCUR ANY COST (OTHER THAN BONDING) UNTIL THE OWNER HAS CONFIRMED THAT THE RIGHT-OF-WAY HAS BEEN OBTAINED.

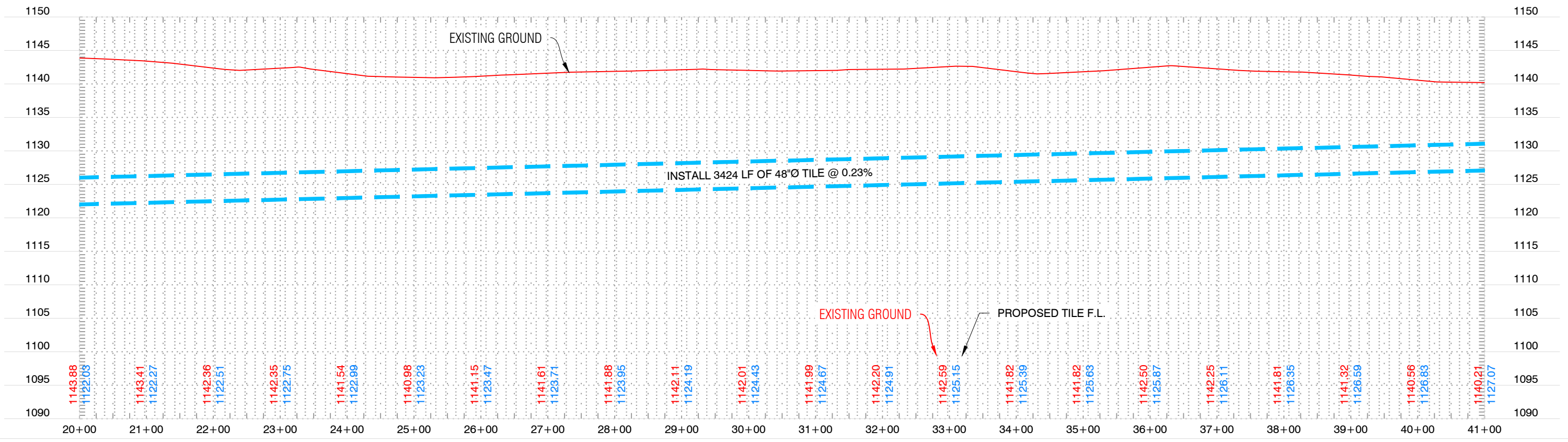

J:\6830-D\Drawings\Sheets\6830-D Sheets (Plan&Profile).dwg - 10:02 PLAN AND PROFILE - 02-18-21 - 10:08am - ZJS443

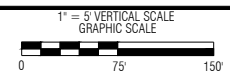

NO.	REVISION	BY	DATE	NO.	REVISION	BY	DATE

CGA Clapsaddle-Garber Associates, Inc.
 739 Park Avenue
 Ackley, Iowa 50901
 Ph 641-847-3279
 www.cgaconsultants.com

DESIGNED: ZJS DATE: ---
 DRAWN: KMN DATE: ---
 CHECKED: ZJS DATE: ---
 APPROVED: LOG DATE: ---

DRAINAGE DISTRICT 56
 HARDIN CO, IOWA

PLAN AND PROFILE

PROJECT NO. 6830.4
 SHEET NO. D.02

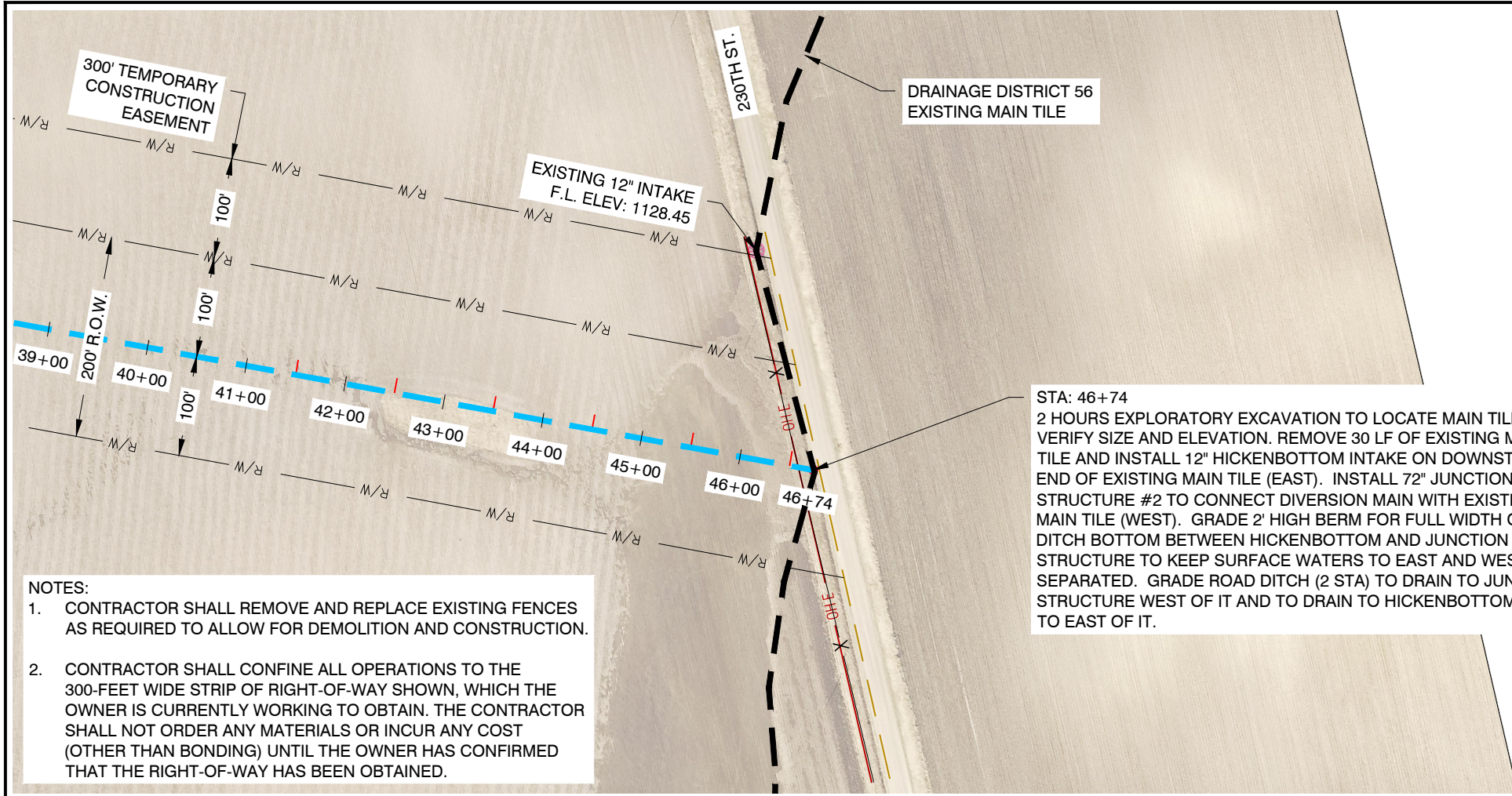

STA: 46+74
 2 HOURS EXPLORATORY EXCAVATION TO LOCATE MAIN TILE AND VERIFY SIZE AND ELEVATION. REMOVE 30 LF OF EXISTING MAIN TILE AND INSTALL 12" HICKENBOTTOM INTAKE ON DOWNSTREAM END OF EXISTING MAIN TILE (EAST). INSTALL 72" JUNCTION STRUCTURE #2 TO CONNECT DIVERSION MAIN WITH EXISTING MAIN TILE (WEST). GRADE 2' HIGH BERM FOR FULL WIDTH OF DITCH BOTTOM BETWEEN HICKENBOTTOM AND JUNCTION STRUCTURE TO KEEP SURFACE WATERS TO EAST AND WEST SEPARATED. GRADE ROAD DITCH (2 STA) TO DRAIN TO JUNCTION STRUCTURE WEST OF IT AND TO DRAIN TO HICKENBOTTOM INTAKE TO EAST OF IT.

- NOTES:**
- CONTRACTOR SHALL REMOVE AND REPLACE EXISTING FENCES AS REQUIRED TO ALLOW FOR DEMOLITION AND CONSTRUCTION.
 - CONTRACTOR SHALL CONFINE ALL OPERATIONS TO THE 300-FOOT WIDE STRIP OF RIGHT-OF-WAY SHOWN, WHICH THE OWNER IS CURRENTLY WORKING TO OBTAIN. THE CONTRACTOR SHALL NOT ORDER ANY MATERIALS OR INCUR ANY COST (OTHER THAN BONDING) UNTIL THE OWNER HAS CONFIRMED THAT THE RIGHT-OF-WAY HAS BEEN OBTAINED.

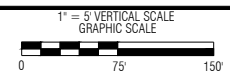
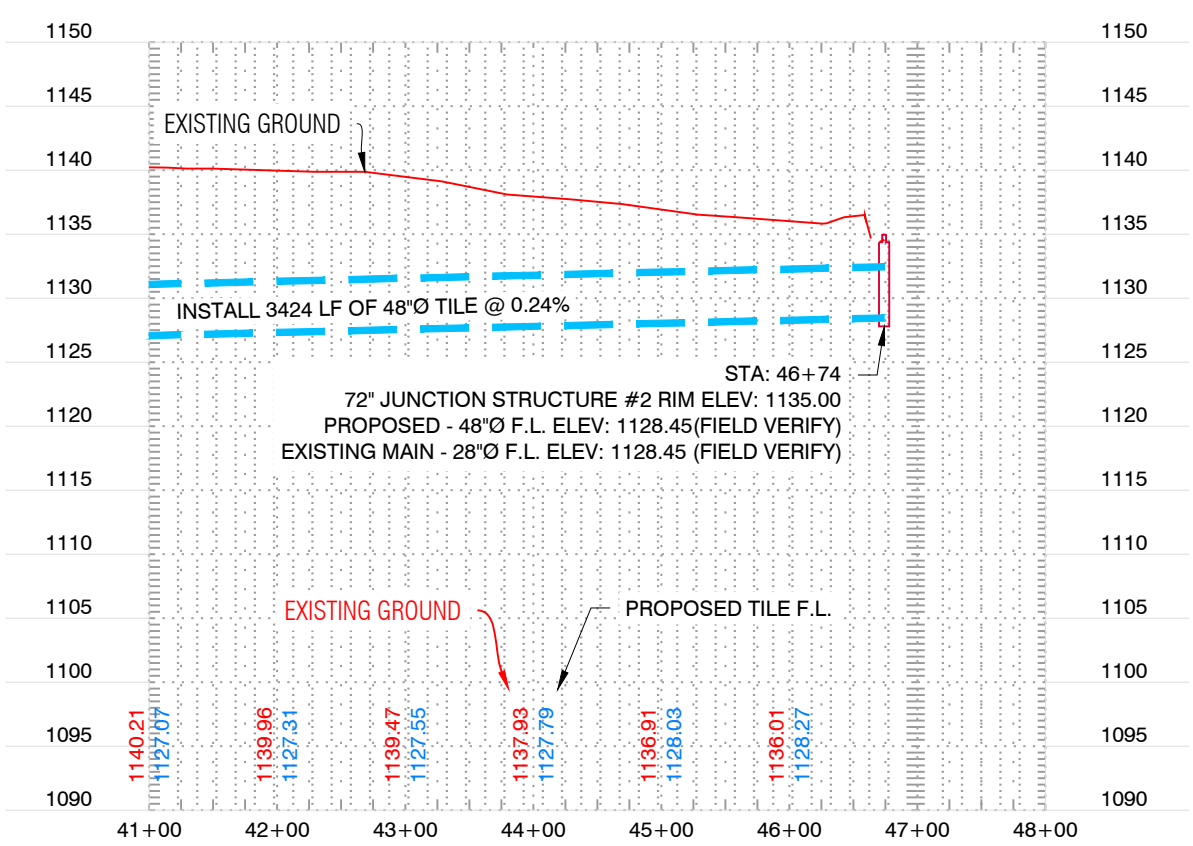

NO.	REVISION	BY	DATE	NO.	REVISION	BY	DATE

CGA Clapsaddle-Garber Associates, Inc.
 739 Park Avenue
 Ackley, Iowa 50801
 Ph 641-847-3273
 www.cgaconsultants.com

DESIGNED: ZJS DATE: ---
 DRAWN: KMN DATE: ---
 CHECKED: ZJS DATE: ---
 APPROVED: LOG DATE: ---

DRAINAGE DISTRICT 56
 HARDIN CO, IOWA

PLAN AND PROFILE

PROJECT NO. 6830.4
 SHEET NO. D.03

J:\6830-DWG\Drawings\Sheets\6830.4-D Streets (Plan&Profile).dwg - 10.03 PLAN AND PROFILE - 02-18-21 - 10:08am - ZJS443